

SR90 Series (SR91, SR92, SR93, SR94) Digital Controller Instruction Manual

Thank you for purchasing a Shimaden product.
Please check that the delivered product is the correct item you ordered.
Please do not begin operating this product before you read this instruction manual
thoroughly and understand its contents.

Notice: Please ensure that this instruction manual is given to the final user of the instrument.

Preface: This instruction manual is meant for those who will be involved in the wiring, installation, operation and routine maintenance of the SR90 series (SR91, SR92, SR93 and SR94). It describes matters to be attended to in handling the SR90 series, how to install it, its wiring, its functions and operating procedures. Keep this manual at the work site while handling the instrument and follow the guidance provided herein

Contents

| | |
|--|--|
| <ul style="list-style-type: none"> 1. Safety Rules..... 2 2. Introduction..... 3 <ul style="list-style-type: none"> 2-1. Check before Use..... 3 2-2. Handling Instruction..... 4 3. Installation and Wiring..... 4~7 <ul style="list-style-type: none"> 3-1. Installation Site..... 4 3-2. Mounting..... 4 3-3. External Dimensions and Panel Cutout..... 5 3-4. Wiring..... 6 3-5. Terminal Layout..... 7 3-6. Terminal Arrangement Table..... 7 4. Names and Functions of Parts on Front Panel..... 8 5. Explanation of Screens and Setting..... 9~18 <ul style="list-style-type: none"> 5-1. Parameter Flow..... 9 5-2. Display upon Power-ON..... 10 5-3. How to Change Screens..... 10 <ul style="list-style-type: none"> (1) How to Change Screens in Screen Group 0..... 10 (2) How to Change Screen Group 0 to/from Screen Group 1..... 10 (3) How to Change Screens in Screen Group 1..... 10 (4) How to Change Set Values (Data)..... 10 5-4. Before Starting Up..... 11 <ul style="list-style-type: none"> (1) Checking of Wiring..... 11 (2) Application of Operating Power..... 11 (3) Setting of Measuring Range..... 11 (4) Setting of Control..... 11 (5) Setting of Control Output Characteristics..... 11 (6) Setting of Event Type..... 11 (7) Setting of Analog Output..... 11 (8) Note on Initialization Following Data Change..... 11 5-5. Procedure of Setting in Screen Group 0..... 11 <ul style="list-style-type: none"> (1) Setting of Target Set Value..... 11 (2) Manual Setting of Control Output..... 11 (3) AT (Auto Tuning)..... 12 (4) Setting of Event Set Value..... 12 (5) Set Value Bias..... 13 5-6. Explanation of Screen Group 0 and Setting..... 14 | <ul style="list-style-type: none"> 5-7. Explanation of Screen Group 1 and Setting..... 14~18 <ul style="list-style-type: none"> (1) Setting of Key lock..... 14 (2) Setting of Output..... 15 (3) Setting of Event..... 16 (4) Heater Current Monitor Screen..... 16 (5) Setting of Heater Break/Loop Alarm..... 16 (6) Setting of Analog Output Type..... 16 (7) Setting of Communication..... 17 (8) Setting of Control Output Characteristic..... 17 (9) Setting of Soft Start Time..... 17 (10) Setting of SV Limiter..... 17 (11) Setting of PV Bias Value..... 18 (12) Setting of PV Filter Time..... 18 (13) Setting of Measuring Range Code..... 18 (14) Setting of Temperature Unit..... 18 (15) Setting of Input Scaling..... 18 5-8. Table of Measuring Range Codes..... 18 6. Explanation of Functions..... 19~20 <ul style="list-style-type: none"> 6-1. Events..... 19 6-2. Setting of Event Standby Action..... 19 6-3. Alarm Actions Diagrams..... 19 6-4. P.I.D..... 19 6-5. Manual Reset..... 20 6-6. Lower Limit and Higher Limit Setting Limiters..... 20 6-7. Proportional Cycling Time..... 20 6-8. Auto Return Function..... 20 6-9. Control Output Characteristics..... 20 6-10. Soft Start..... 20 7. Maintenance and Troubleshooting..... 21~22 <ul style="list-style-type: none"> 7-1. Procedure of Maintenance Replacement and Matters to Be Attended to..... 21 7-2. Causes of Trouble and Troubleshooting..... 21 7-3. Error Codes, Causes and Remedies..... 22 8. Record of Parameter Setting..... 23 9. Specifications..... 24~25 |
|--|--|

1. Safety Rules

For matters regarding safety, potential damage to equipment and/or facilities, additional instructions and notes are indicated by the following headings.

⚠ WARNING: This heading indicates hazardous conditions that could cause injury or death of personnel unless extreme caution is exercised.

⚠ CAUTION: This heading indicates hazardous conditions that could cause damage to equipment and/or facilities unless extreme caution is exercised.

NOTE: This heading indicates additional instructions and/or notes.

The mark \oplus represents a protective conductor terminal. Make sure to ground it properly.

⚠ WARNING

The SR90 series is designed for controlling temperature, humidity and other physical quantities of general industrial equipment. Avoid using it for control of devices upon which human life is dependent. When used, adequate and effective safety measures must be taken. No warranty is valid in the case of an accident arising from the use of this product without having taken such safety measures.

⚠ WARNING

- For using this instrument, house it in a control box or the like to prevent terminals from coming into contact with personnel.
- Do not draw out the instrument out from its case. Do not let your hand or any conductive body into the case. It may lead to serious injury or death due to an electric shock.
- Make sure to ground protective conductor terminals.

⚠ CAUTION

To avoid damage to connected equipment, facilities or the SR90 itself due to a fault of the product, safety measures must be taken before usage, such as the installation of a fuse, an overheating protection device and the like. No warranty is valid in the case of an accident arising from the use of this product without such safety measures.

⚠ CAUTION

- The alert mark \triangle on the plate affixed to the instrument: On the terminal nameplate affixed to the case of this instrument, the alert mark \triangle is printed. This is to warn you of the risk of electric shock which may result if the charger is touched while being energized.
- As a means to turn the power off, a switch or a breaker should be installed in the external power circuit to be connected to the power terminal of the instrument. Fix the switch or the breaker adjacently to the instrument in a position which allows it to be operated with ease, with an indication that it is a means of turning the power off. Use a switch or a breaker which meets IEC947 requirements.
- Fuse: Since the instrument does not have a built-in fuse, do not forget to install a fuse in the power circuit to be connected to the power terminal. A fuse should be positioned between a switch or a breaker and the instrument and mounted on the L side of the power terminal. Fuse rating/characteristics: 250 VAC 0.5 A/medium lagged or lagged type. Use a fuse which meets IEC127 requirements.
- Voltage/current of a load to be connected to the output terminal and the alarm terminal should be within a rated range. Otherwise, the temperature will rise to reduce the life of the product and/or to result in problems with the product. For rated voltage/current, see 9. Specifications. The output terminal should be connected with a device which meets the requirements of IEC1010.
- A voltage/current different from that of the input specification should not be applied to the input terminal. It may reduce the life of the product and/or result in problems with the product. For rated voltage/current, see 9. Specifications. In the case of voltage or current input, the input terminal should be connected to a device which meets IEC1010 requirements. The instrument is provided with a draft hole for heat discharge. Take care to prevent metal and other foreign matter from entering into it. Failure to do so may result in trouble with the instrument or may even cause a fire.
- Do not block the draft hole or allow dust or the like to stick to it. A rise in temperature or insulation failure may result in a reduction of the life of the product and/or problems with it or may cause a fire. For spaces between installed instruments, refer to 3-3. External Dimensions and Panel Cutout.
- It should be noted that repeated tolerance tests against voltage, noise, surge, etc., may lead to deterioration of the instrument.
- Users are prohibited from remodeling the product or using it in a prohibited way.

2. Introduction

2-1. Check before Use

This product has been fully inspected for quality assurance prior to shipment. Nevertheless, you are requested to make sure that there is no error, damage or shortage of delivered items by checking the model codes and the external view of the product and the number of accessories.

① Confirmation of Model Codes

Check the model codes affixed to the case of the product to ascertain if the respective codes designate what was specified when you ordered it, referring to the following code table:

SR90 series is based on 3 types of selectable codes SR91-SR92-SR93 and SR94. Please refer to the following example of model codes.

Example of SR91 model type codes:

S R 9 1 - 8 Y - 9 0 - 0 N 0

-
- 1. Series
 - 2. Input
 - 3. Control output (1)
 - 4. Power supply
 - 5. Event
 - 6. Option
 - Control output (2)
 - heater break alarm
 - 7. Remarks
 - Analog output
 - Communication
 - Set value bias

SR91

8: Multi-input, Thermocouple, R.T.D., Voltage (mV),
 4: Current (mA), 6: Voltage (V)
 Y: Contact, I: Current, P: SSR drive voltage, V: Voltage
 90: 100-240V AC, 08: 24V AC/DC
 0: None, 1: Event output
 N: None
 Y: Contact, I: Current, P: SSR drive voltage, V: Voltage
 1: heater break alarm (30A)
 2: heater break alarm (50A)
 [Selectable only when adjustment output 1 is Y, P and
 event output is added
 3: 0-10mV DC, 4: 4-20mA DC, 6: 0-10V DC
 5: RS-485
 8: Set value bias 1 point
 0: Without, 9: With

Example of SR92 model type codes:

S R 9 2 - 8 Y - N - 9 0 - 0 0 0 0

-
- 1. Series
 - 2. Input
 - 3. Control output (1)
 - 4. Control output (2)
 - 5. Power supply
 - 6. Event output or
Event output +
heater break alarm
 - 7. Analog output
 - 8. Communication or
Set value bias
 - 9. Remarks

SR92

8: Multi-input, Thermocouple, R.T.D., Voltage (mV),
 4: Current (mA), 6: Voltage (V)
 Y: Contact, I: Current, P: SSR drive voltage, V: Voltage
 N: None, Y: Contact, I: Current, P: SSR drive voltage,
 V: Voltage
 90: 100-240V AC, 08: 24V AC/DC
 0: None, 1: Event output
 2: Event output + heater break alarm 30A
 3: Event output + heater break alarm 50A
 [Both 2: 3: selectable only when adjustment output 1 is Y, P.]
 0: None, 3: 0-10mV DC, 4: 4-20mA DC, 6: 0-10V DC
 0: None, 5: RS-485, 7: RS-232C,
 8: Set value bias 1 point
 0: Without, 9: With

Example of SR93, SR94 model type codes:

S R 9 3 - 8 Y - N - 9 0 - 0 0 0 0

-
- 1. Series
 - 2. Input
 - 3. Control output (1)
 - 4. Control output (2)
 - 5. Power supply
 - 6. Event output or
Event output +
heater break alarm
 - 7. Option
 - Analog output
 - Set value bias
 - Analog output +
Set value bias
 - 8. Remarks
 - Communication

SR93, SR94

8: Multi-input, Thermocouple, R.T.D., Voltage (mV),
 4: Current (mA), 6: Voltage (V)
 Y: Contact, I: Current, P: SSR drive voltage, V: Voltage
 N: None, Y: Contact, I: Current, P: SSR drive voltage,
 V: Voltage
 90: 100-240V AC, 08: 24V AC/DC
 0: None, 1: Event output
 2: Event output + heater break alarm 30A
 3: Event output + heater break alarm 50A
 [Both 2: 3: selectable only when adjustment output 1 is Y, P.]
 00: None
 30: 0-10mV DC, 40: 4-20mA DC, 60: 0-10V DC
 08: Set value bias 1 point
 38: 0-10mV DC + set value bias 1 point
 48: 4-20mA DC + set value bias 1 point
 68: 0-10V DC + set value bias 1 point
 05: RS-485, 07: RS-232C,
 0: Without, 9: With

- ② Accessories
 - This instruction manual 1 copy
 - The Communication interface instruction manual (in case optional communication function is added) 1 copy
 - Unit seals 1 sheet
 - Current detector for heater break alarm (CT) (in case optional heater break alarm function is added)
 - For 30A: Model CTL-6-S 1 pc.
 - For 50A: Model CTL-12-S36-8 1 pc.

NOTE: For any problem with the product, shortage of accessories or request for information, please contact our agent or our sales office in your neighborhood.

2-2. Handling Instruction

- ① Do not operate the keys on the front panel with a hard or sharply pointed object. Operate the keys only by softly touching them by your fingertips.
- ② When cleaning the instrument, wipe it gently with a dry cloth. Never use solvent such as a thinner.

3. Installation and Wiring

3-1. Installation Site (environmental conditions)

CAUTION

This instrument should not be used in any of the places mentioned below. Selection of these places may result in trouble with the instrument, damage to it or even a fire.

- ① Where flammable gas, corrosive gas, oil mist and particles that can deteriorate electrical insulation are generated or abundant.
- ② Where the temperature is below -10°C or above 50°C.
- ③ Where the relative humidity is above 90%RH or below the dew point.
- ④ Where highly intense vibration or impact is generated or transferred.
- ⑤ Near high voltage power lines or where inductive interference can affect the operation of the instrument.
- ⑥ Where the instrument is exposed to dew drops or direct sunlight.
- ⑦ Where the height is above 2000 m.
- ⑧ Outdoors.

NOTE: The environmental conditions belong to the installation category II of IEC664 and the degree of pollution is 2.

3-2. Mounting

CAUTION

For safety's sake and to protect the functionality of the product, do not draw out its body from the case. If it needs to be drawn out for replacement or repair, call our agent or our sales office in your neighborhood.

- ① Cut a hole for mounting the controller in the panel by referring to the cutout drawing in Section 3-3.
- ② The panel thickness should be 1.0 ~ 4.0 mm.
- ③ As the instrument is provided with pawls for fixing, just press it firmly from the front of the panel.
- ④ The SR90 series instrument is designed in a panel-mounting mode. Never use it without mounting on the panel.

3-3. External Dimensions and Panel Cutout

SR91

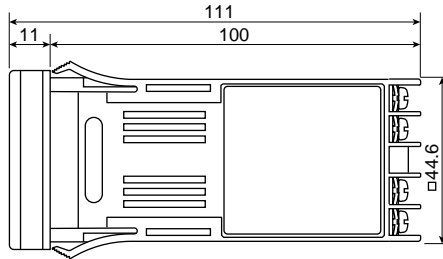
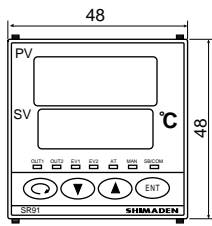

Panel cutout drawing

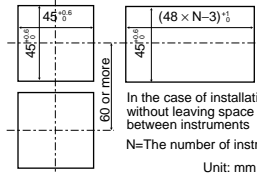

In the case of installation without leaving space between instruments
N=The number of instruments
Unit: mm

SR92

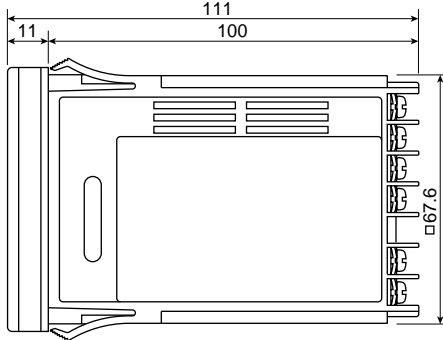
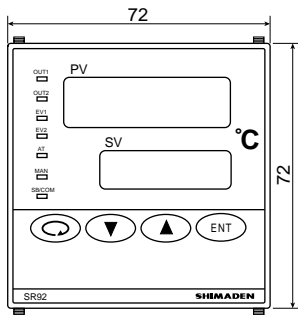

Panel cutout drawing

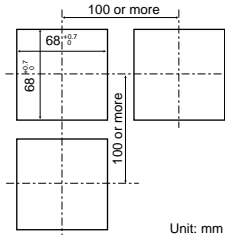

Unit: mm

SR93

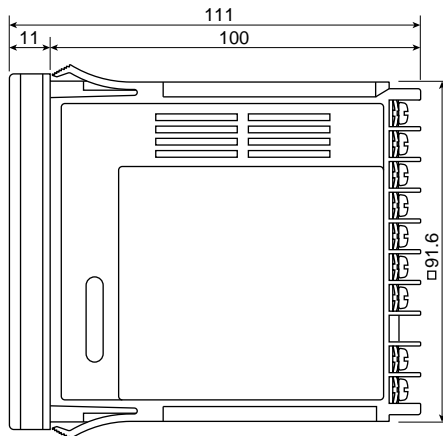
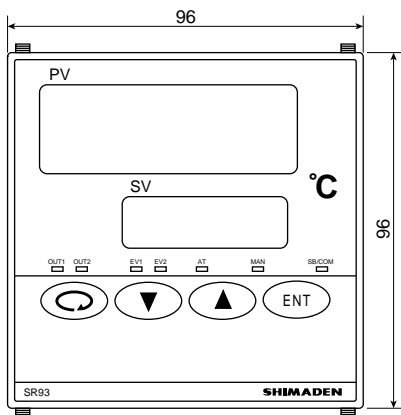

Panel cutout drawing

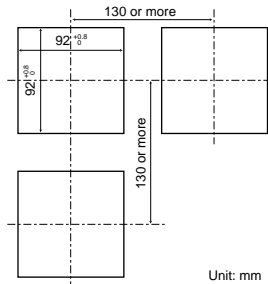

Unit: mm

SR94

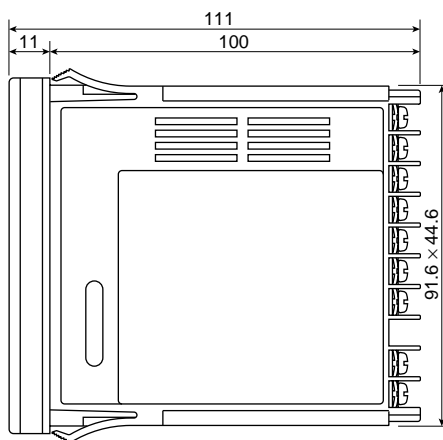
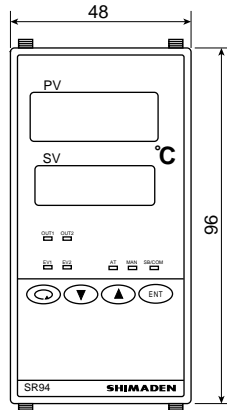

Panel cutout drawing

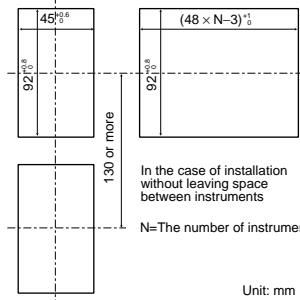

In the case of installation without leaving space between instruments
N=The number of instruments
Unit: mm

External dimensions of current detectors (CT) of heater break alarm

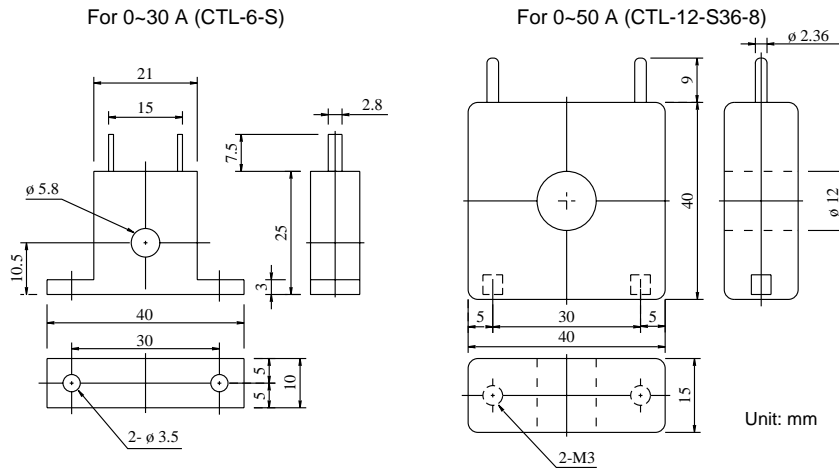

3-4. Wiring

In the wiring operation, close attention should be paid to the following:

⚠ WARNING

- Make sure to disconnect this product from any power source during the wiring operation to prevent an electric shock.
- Be certain that the protective conductor terminal (⊕) is properly grounded. Otherwise, an electric shock may result.
- To prevent an electric shock, do not touch wired terminals and other charged elements while they are being energized.

- ① In the wiring operation, follow the terminal layout shown in Section 3-5 and the terminal arrangement in Section 3-6 and make sure to carry out the correct wiring process.
- ② Use a press-fit terminal which fits an M3.5 screw and has a width of 7 mm or less.
- ③ In the case of thermocouple input, use a compensating conductor compatible with the selected type of thermocouple.
- ④ In the case of R.T.D. input, the resistance of a single lead wire must be 5Ω or less and the three wires must have the same resistance.
- ⑤ The input signal wire must not be accommodated with a high-voltage power cable in the same conduit or duct.
- ⑥ Shield wiring (single point grounding) is effective against static induction noise.
- ⑦ Twisting the input wires at short and equal intervals is effective against electromagnetic induction noise.
- ⑧ In wiring for power supply, use a wire or cable whose performance is equal to or higher than the 600V vinyl insulated wire having a sectional area of 1 mm^2 or larger.
- ⑨ The wire for grounding must have a sectional area of 2 mm^2 or larger and must be grounded at a grounding resistance of 100Ω or less.
- ⑩ Clamp the screws of terminals firmly.
Clamping torque: $1.0\text{ N}\cdot\text{m}$ ($10\text{ kgf}\cdot\text{cm}$)
- ⑪ If the instrument appears to be easily affected by power supply noise, use a noise filter to prevent malfunctioning. Mount the noise filter on the grounded panel and make the wire connection between the noise filter output and the power line terminals of the controller as short as possible.

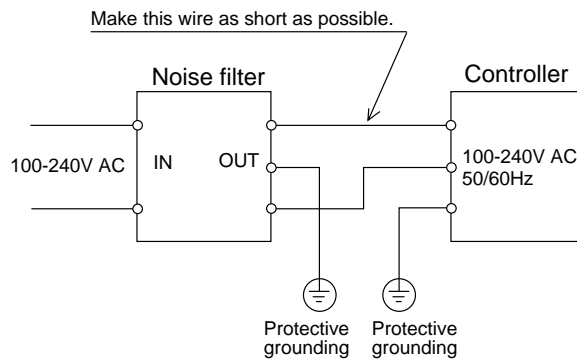

Recommended noise filter: TDK's ZMB2203-13

⑫ Connection of current detector (CT)

Insert a load line through the hole of the noise filter meant for the controller. With this wire, connect the secondary side terminal of CT to the CT input terminal of the SR90 series controller.

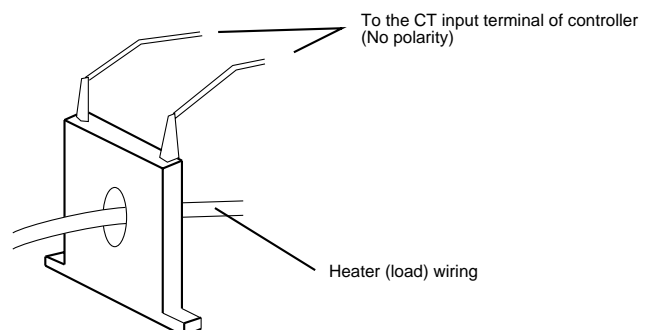

3-5. Terminal Layout (Follow the terminal layout and terminal arrangement table shown below in your wiring operation.)

SR91

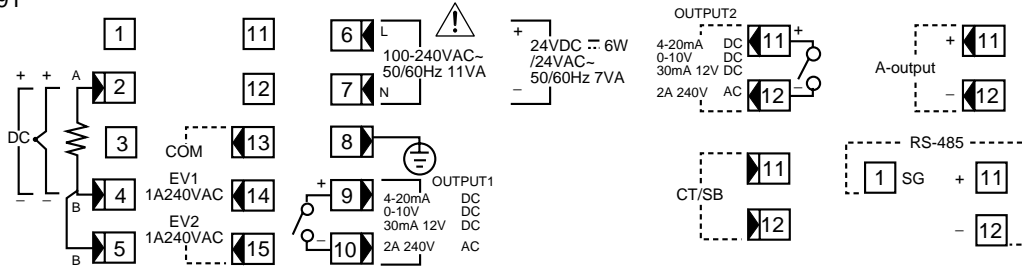

SR92

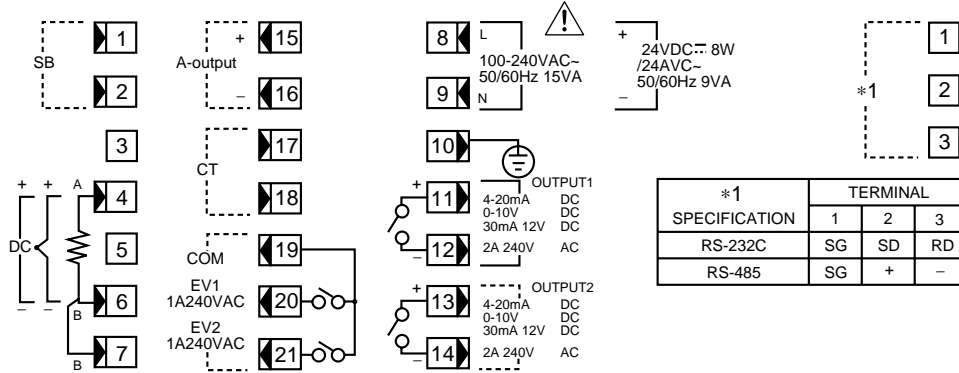

SR93 & SR94

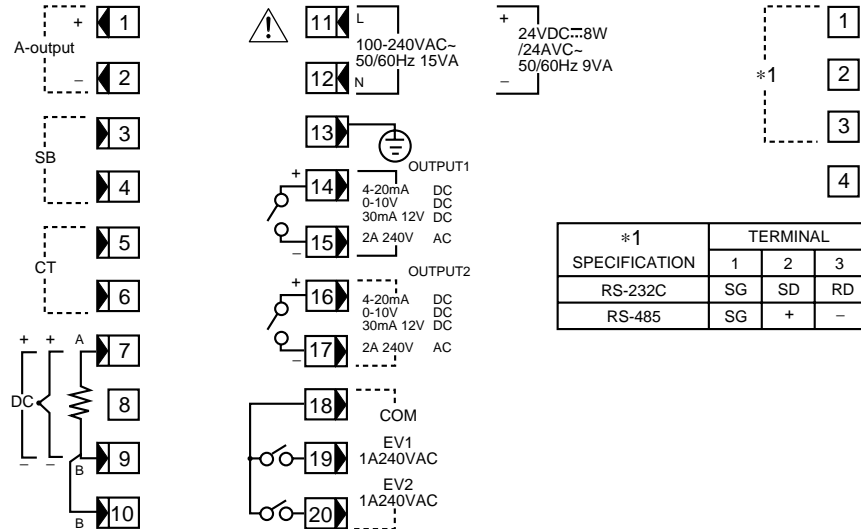

3-6. Terminal Arrangement Table

| Name of terminal | Description/Code | Terminal No. | | |
|---------------------------|--|-----------------------|---------------------|---------------------|
| | | SR91 | SR92 | SR93 • 94 |
| Power supply | 100-240V AC/24V AC: L, 24V DC: + 100-240V AC/24V AC: N, 24V DC: - | 6 7 | 8 9 | 11 12 |
| Protective conductor | ⊕ | 8 | 10 | 13 |
| Input | R.T.D.: A, thermocouple/voltage/current: + R.T.D.: B, thermocouple/voltage/current: - R.T.D.: B | 2 4 5 | 4 6 7 | 7 9 10 |
| Control output 1 | Contact: NO, SSR drive voltage/Voltage/Current: + Contact: NO, SSR drive voltage/Voltage/Current: - | 9 10 | 11 12 | 14 15 |
| Control output 2 (option) | Contact: NO, SSR drive voltage/Voltage/Current: + Contact: NO, SSR drive voltage/Voltage/Current: - | 11 12 | 13 14 | 16 17 |
| Event output (option) | COM EV1 EV2 | 13 14 15 | 19 20 21 | 18 19 20 |
| Heater break (option) | CT input | 11-12 | 17-18 | 5-6 |
| Analog output (option) | + - | 11 12 | 15 16 | 1 2 |
| Communication (option) | RS-232C: SD, RS-485: + RS-232C: RD, RS-485: - SG RS-485: + RS-485: - | 1 11 12 | 2 3 1 | 2 3 1 |
| Set value bias (option) | | 11-12 | 1-2 | 3-4 |

NOTE:
With thermocouple/voltage/current input, shorting across B and B terminal will cause an error.

NOTE:
The optional functions of the SR90 are subject to the following conditions:

SR91:
Only one of control output 2, heater break alarm, analog output, communication and set value bias is selectable.

SR92:
Communication and set value bias are not selectable simultaneously.

SR93/94:
Communication and analog output, or communication and set value bias are not selectable simultaneously.
Simultaneous selection of analog output and set value bias is possible, though.

4. Names and Functions of Parts on Front Panel

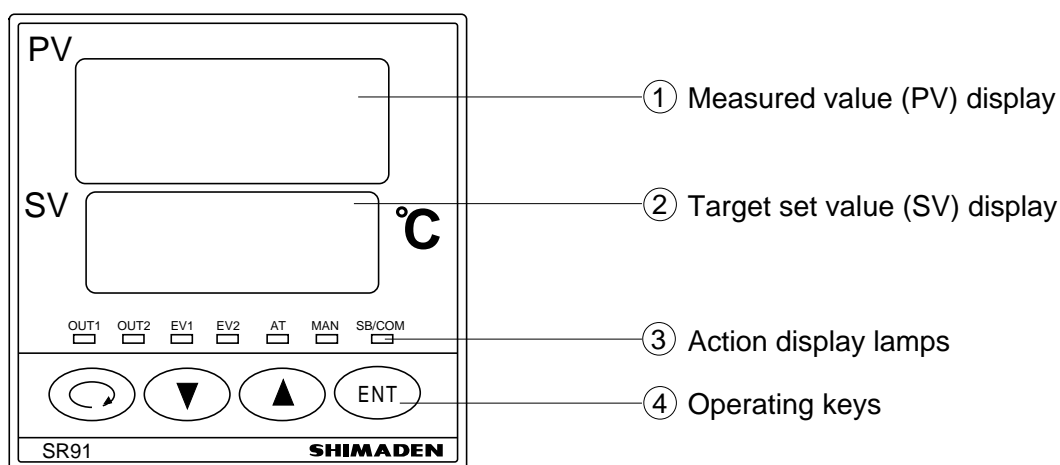





| Name | Function |
|----------------------------------|---|
| ① Measured value (PV) display: | <ol style="list-style-type: none"> (1) Present measured value (PV) is displayed on the screen group 0, basic screen and output display screens (OUT1 and OUT2). (red) (2) Type of parameter is shown on each parameter screen. |
| ② Target set value (SV) display: | <ol style="list-style-type: none"> (1) Target set value (SV) is displayed on the basic screen of the screen group 0. (green) (2) Present output value is displayed by % on control output monitor screens (OUT1, OUT2) of the screen group 0. (3) Selected item and set value are displayed on each parameter screen. |
| ③ Action display lamps: | <ol style="list-style-type: none"> (1) Control output indicators: OUT1 and OUT2 (option) (green) <ul style="list-style-type: none"> • OUT1 lights when output turns ON and goes out when it turns OFF during contact or SSR drive voltage output. • The brightness changes in proportion to output increase/decrease during current or voltage output. • OUT2 functions only if the option is added. (2) Event output indicators: EV1/EV2 (option) (orange) <ul style="list-style-type: none"> • Light when assigned events (including heater break/loop alarm) turn ON if event option is added. (3) Auto tuning action indicator: AT (green) <ul style="list-style-type: none"> • Flashes when ON is selected by key on the AT action selection screen and AT is executed by key, and goes out when AT terminates automatically or is released. (4) Manual control output action indicator: MAN (green) <ul style="list-style-type: none"> • Flashes when manual control output is selected on control output display screens (OUT1, OUT2); remains unlit during automatic control output. (5) Set value bias/communication indicator: SB/COM (option) (green) <ul style="list-style-type: none"> • Lights when optional set value bias function is added and at the time of shorting across SB terminal (set value bias in action). • Lights when optional communication function is added and COM mode is selected. Goes out when Local is selected for communication mode. |
| ④ Operating keys: | <ol style="list-style-type: none"> (1) (parameter) key <ul style="list-style-type: none"> • Pressing this key on any screen of the screen group 0 and the screen group 1 calls the next screen onto display. • When pressed continuously for 3 seconds, this key functions to move between the basic screen of screen group 0 and the initial screen of screen group 1. • Pressing this key simultaneously with key in the screen group 1 calls the preceding screen onto display. (2) (down) key <ul style="list-style-type: none"> • When pressed on a parameter screen, the decimal point of the rightmost digit flashes and the set data decreases or moves backward. (3) (up) key <ul style="list-style-type: none"> • When pressed on a parameter screen, the decimal point of the rightmost digit flashes and the set data increases or moves forward. (4) (entry/registration) key <ul style="list-style-type: none"> • Used to register a set data changed by means of or key on a parameter screen. • Pressing this key simultaneously with key on a screen of the screen group 1 calls the preceding screen onto display. • When pressed continuously for 3 seconds on the control output screens (OUT1, OUT2), this key functions to switch between automatic output and manual output. |

5. Explanation of Screens and Setting

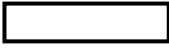
5-1. Parameter Flow (Outline of Parameter Flow displayed below. Set parameter according to the explanation of each setting screen)

NOTE: Four kinds of frame lines signify the following:

-  Screens regularly shown by key operation and other means
-  Screens which may or may not be shown depending on control action modes (PID action or ON/OFF action)
-  Screens shown when appropriate options are added or selected
-  Screens for monitoring (without automatic return after 3 minutes)

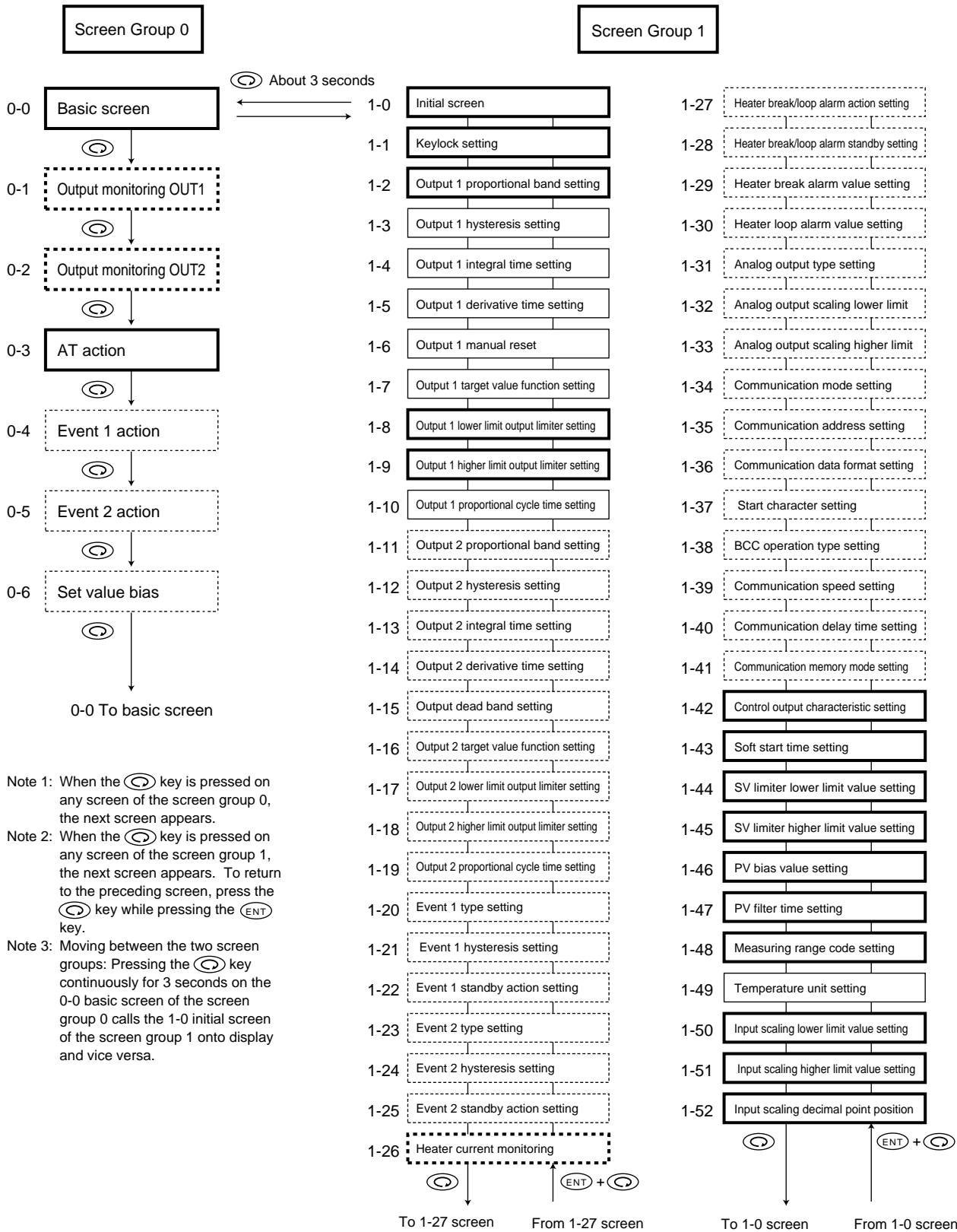

5-2. Display upon Power-ON

When power is applied, initial screens upon power-ON are displayed successively, each for about 1 second. Then the basic screen is displayed.

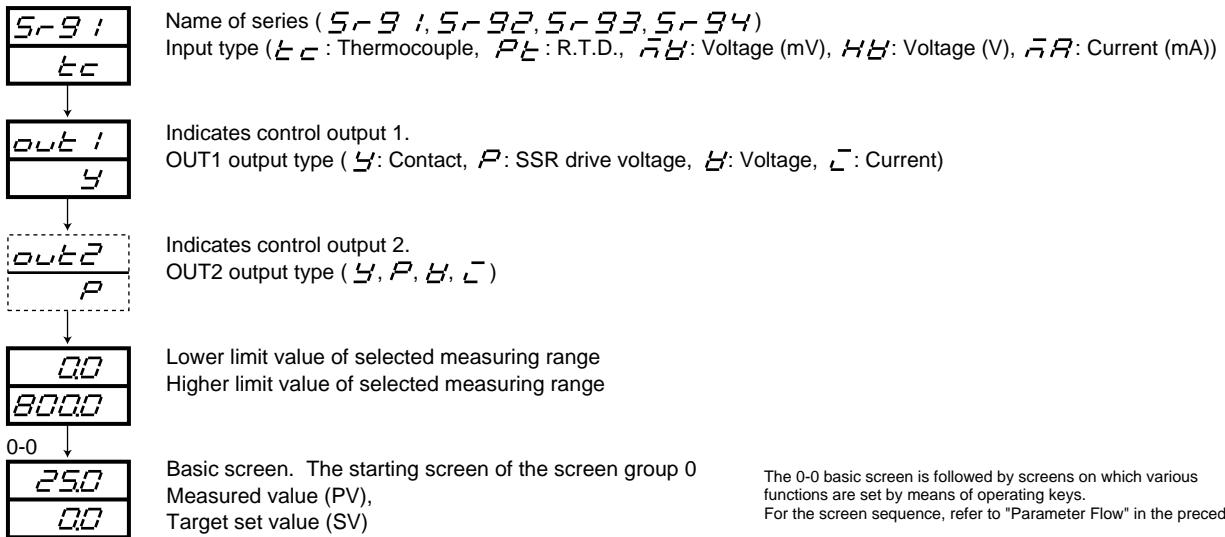

5-3. How to Change Screens

Screen group 0 (the group of screens for setting primarily by the end user)

Screen group 1 (the group of screens for setting primarily by the manufacturer and equipment manufacturers)

(1) How to change screens in screen group 0

Every time the PARA key is pressed, the screen moves to the next and the 0-0 basic screen returns when it is pressed on the last screen.

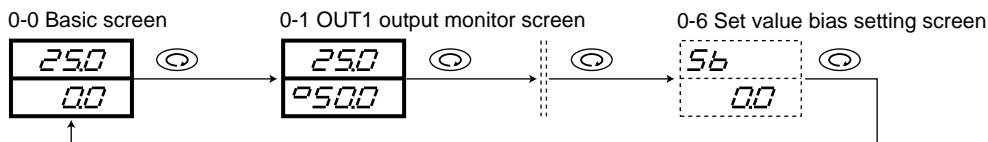

(2) How to change screen group 0 to/from screen group 1

Pressing the key continuously for 3 seconds on the basic screen of the screen group 0 calls the 1-0 initial screen of the screen group 1 onto display. Also by pressing the key continuously on the 1-0 initial screen of screen group 1 calls the basic screen of screen group 0.

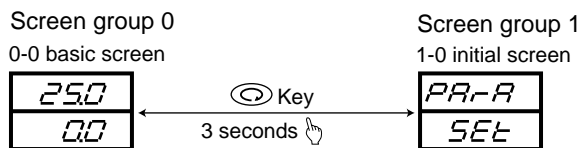

(3) How to change screen in screen group 1

Starting from the 1-0 initial screen of the screen group 1, every time the key is pressed, the next screen appears and the 1-0 initial screen returns when it is pressed on the last screen. By pressing the key while pressing the key in the screen group 1, you can go back to the preceding screen. When the key is pressed while the key is being pressed on the 1-0 initial screen, the last screen of this group, i.e., the 1-52 input scaling decimal point position setting screen appears on the display.

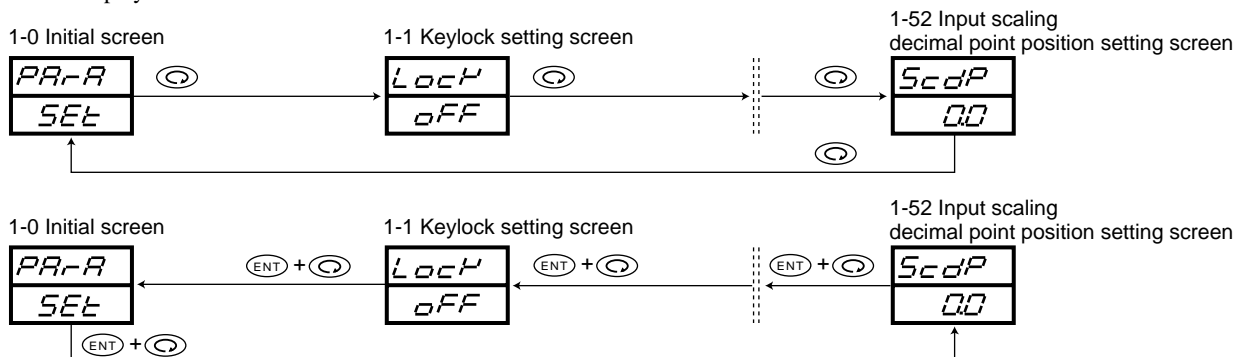

(4) How to change set values (data)

To change data on a screen which is called by pressing the key, use the or key, and register the changed data by pressing the key.

5-4. Before Starting Up





To begin with, check the wiring and set the items listed below by the setting methods of the screen groups. (Factory-set items and items already set by equipment manufacturers need not be set here.)

- (1) **Checking of wiring:** Check that the wiring to connected terminals is carried out properly. Erroneous wiring will result in burnout.
- (2) **Application of operating power:** Apply operating power. The controller is energized and the data display and other lamps light.
- (3) **Setting of measuring range:** Call the 1-48 measuring range code screen of the screen group 1 and select a code from the measuring range codes. For current, voltage or mV input, lower/higher limit values and the position of decimal point should be set. (Depending on a selected code, selection on the 1-49, 1-50 or 1-51 screen will be required.)
- (4) **Setting of control:** In the case of ON-OFF (two-position) action, call the 1-2 output 1 proportional band setting screen of the mode 1 screen group and select OFF and register it. Follow the same procedure for output 2 if the option is added. Omit this setting in the case of AT.
- (5) **Setting of control output characteristics:** Call the 1-42 control output characteristic setting screen of the screen group 1 and select either RA or DA correspondingly to output characteristic specification as shown in the table.
- (6) **Setting of event type:** If the optional event function is added, call the 1-20 event alarm type code setting screen of the screen group 1 and select and register a code.
- (7) **Setting of analog output:** If the optional analog output function is added, call the 1-31 analog output type setting screen of the screen group 1 and select one from the setting range and register it.
- (8) **Note on initialization following data change:** When the code of measuring range, type of event or type of analog output is changed, a set value is initialized and resetting is required.



5-5. Procedure of Setting in Screen Group 0

In the following section 5-6, the flow of setting screens is explained in the next section, "Explanation of Screen Group 0 and Setting." In this section, the procedure of setting is described.

Key operation:

Use the  key to call the next screen. On each setting screen, use the  or  key for selection and the  key for registration. Nevertheless, in case the value of manual control output is changed on the output monitor screen, the  key need not be pressed.

(1) Setting of target set value (SV)



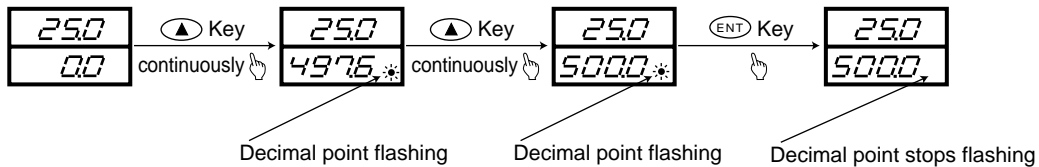

- ① To set a target set value (SV), press the  or  key on the 0-0 basic screen. When either of the keys is pressed continuously, the decimal point of the rightmost digit flashes and the numerical value keeps increasing or decreasing. When it reaches a target set value, press the  key to register.
- ② Once it reaches the target set value, the digit stops flashing. (Setting of a target set value is not possible while auto tuning (AT) is in execution. AT should be relieved for setting.)

Example: 500.0°C is to be set as a target set value.

0-0 basic screen



(2) Manual setting of control output

- 1) **Switching between automatic output and manual output on output monitor screen (OUT1 and OUT2) and setting:**
 To switch auto to manual and vice versa, press the  key for 3 seconds continuously on the output 1 or output 2 screen. Upon turning to manual, the MAN lamp flashes and it remains unlighted during automatic output. To set a target value, press the  or  key on the output monitor screen to keep the numerical value increasing or decreasing until a target value is reached. To release manual output, press the  key again for 3 seconds continuously, and automatic output returns.
 - ① If the output mode of either output 1 or output 2 is changed to manual, the output mode of the other is also changed to manual. Also, if changed to auto, the output of the other will be changed to auto as well.
 - ② In case the output of output 1 is at 100.0%, 0999 is displayed on the output 1 screen and the decimal point of 0 flashes.
 - ③ In case the output of output 2 is at 100.0%, 0999 is displayed on the output 2 screen and the decimal point of 0 flashes.
 - ④ In case output is of contact or SSR drive voltage and OFF is set for proportional band (P), the value of output will be 0.0% or 100.0%.
 - ⑤ In case output is of voltage or current and OFF is set for proportional band (P), the value of output will be the lower limit value or the higher limit value of a set limiter.
 While auto tuning (AT) is in execution, switching to manual output is not possible. It should be done after releasing AT.

0-1 Output monitor screen

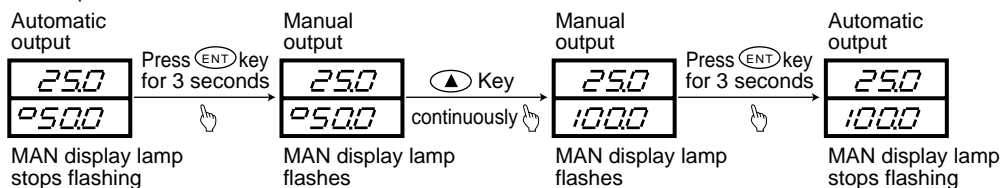

- 2) Supplementary explanation of using the manual adjustment output Monitor screens (OUT1 and OUT2) and automatic/manual output:
- ① When automatic output is changed to manual, output is put in a balanceless/bumpless action and the value of output right before the change is displayed. Changing from manual to auto also causes bumpless action but not if the PV value is outside the proportional band.
 - ② If power supply is shut off and power is applied again, control output continues to be in auto or manual at the time when power supply is shut off.
- Note: Although a change to another screen in the manual mode is possible, it should be noted that control output is manual in this case. Flashing of the MAN monitor LED indicates that the manual mode is ON.

(3) AT (auto tuning)

AT is the function of automatically processing and setting P.I.D., the parameters of P.I.D. control. Processing time differs depending on the details of control.

1) Execution of AT

Pressing the \blacktriangle or \blacktriangledown key on the 0-3 AT action control screen changes OFF displayed on the bottom to ON and the decimal point of the rightmost digit flashes. Then press the ENT key. The AT lamp flashes and AT starts. When AT is executed, ON/OFF action of output in response to rising and falling of the measured value from the target set value is repeated several times to store PID values internally and AT ends. At the same time control using stored PID values begins and the AT lamp goes out.

0-3 AT action control screen

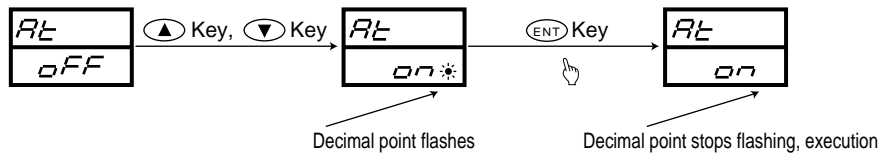

2) Halfway releasing of AT

To stop AT in the middle of execution, select OFF by using the \blacktriangle or \blacktriangledown key on the AT action control screen and by pressing the ENT key, releases the AT and the decimal point and the AT lamp stops flashing.

0-3 AT action control screen

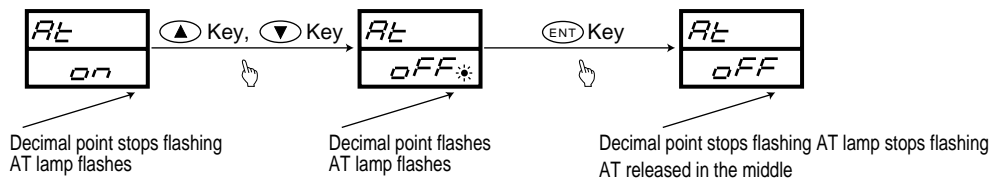

Note: In case AT is released in the middle, PID values are not changed.

3) In the following conditions, AT is unable to be executed:

- ① Control output is in manual. (The AT screen not displayed.)
- ② Scaleover of PV (measured value). (The AT screen not displayed.)
- ③ OFF is selected for proportional band (P) of output 1. (The AT screen not displayed.)
- ④ Lock No. 2 or 3 selected on the keylock screen.

4) If the following occur while AT is in execution, AT will be released:

- ① The output value has been at 0% or 100% continuously for 200 minutes.
- ② Scaleover of PV value

5) AT works as follows in the instrument of two-output specifications:

- ① RA characteristic: PID constants are common to OUT1 and OUT2.
- ② DA characteristic: AT is executed only for OUT1 and while AT is in execution, output of OUT2 is at 0% or the lower limiter value of output limiter.

(4) Setting of event set value

Before a value is set, an event type should be set as described in the following paragraph, 1) Event type setting. When an event type code is changed, however, all the set values (data) concerning the event are initialized.

1) Event type (alarm type) setting

Call the 1-20 event 1 type code setting screen of the screen group 1 and select one from the type codes Hd, Ld, od, id, HA and LA by pressing the \blacktriangle and \blacktriangledown keys. Then register it by the ENT key.

There are the following 6 event type (alarm type) codes: Hd: Higher limit deviation, Ld: Lower limit deviation, od: Outside higher/lower limit deviations, ld: Within higher/lower limit deviations, HA: Higher limit absolute value, LA: Lower limit absolute value. A selected code is displayed and an action point is to be set for the selected event type (alarm type). (OFF: None, SO: Scaleover, and HB: Heater break/loop alarm are screen display only.)

2) Setting of event value

The 0-4 event 1 set value setting screen or the 0-5 event 2 set value setting screen will set. It will be on display when either of the previous 6 types of event is selected.

Set the aimed value by pressing the \blacktriangle or \blacktriangledown key on screen. When the ENT key is pressed to register the set event value, the decimal point stops flashing.

Setting ranges: Higher limit deviation value or lower limit value: -1999 ~ 2000 units

Outside or within higher/lower limit deviation values: 0 ~ 2000 units

Higher limit absolute value or lower limit absolute value: Within measuring range

(No event value can be set while AT (auto tuning) is in execution. Set after releasing AT.)

0-4 Event 1 set value screen

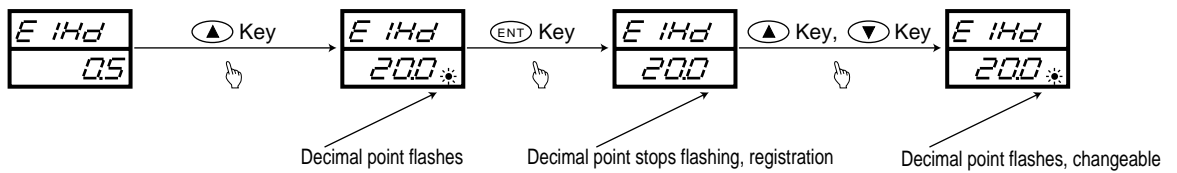

3) Changing the event value

To change the value, pressing the \blacktriangle or the \blacktriangledown key causes the decimal point to flash and the value will change. Press the ENT key to set your aimed value, the decimal points will stop flashing.

(5) Set value bias

1) Set value bias

As an optional function, additional setting of another target set value is possible.

It is set as a set value bias which indicates a deviation from the target set value.

For instance, when 20°C has been set as the target set and you want to set another set value at 30°C, set the set value bias at +10°C.

The set value bias becomes effective when the SB terminals are closed.

When the SB terminals are open, the target set value becomes effective.

This function is used conveniently to switch a target value between "summer and winter"/"day and night" and the like.

2) Setting of set value bias

In case the optional set value bias function is added, press the \blacktriangle or \blacktriangledown key on the 0-6 screen to set a numerical value of set value bias and register the value by pressing the ENT key. The decimal point stops flashing.

The set value remains effective while the SB terminals are shorted and is added to the target set value. When a set value bias is set, the SB/COM lamp lights.

Setting range: -1999~5000 units

5-6. Explanation of Screen Group 0 and Setting

Screen Group 0

Key operation:

The key is used to proceed to the next screen. The key and the key are used for selection on each setting screen and the key is used for registration. The key need not be pressed, however, when a manual control output value is changed on the output monitor screen.

To move between the screen group 0 and the screen group 1, press the key continuously for 3 seconds on the 0-0 basic screen or the 1-0 initial screen as described below.

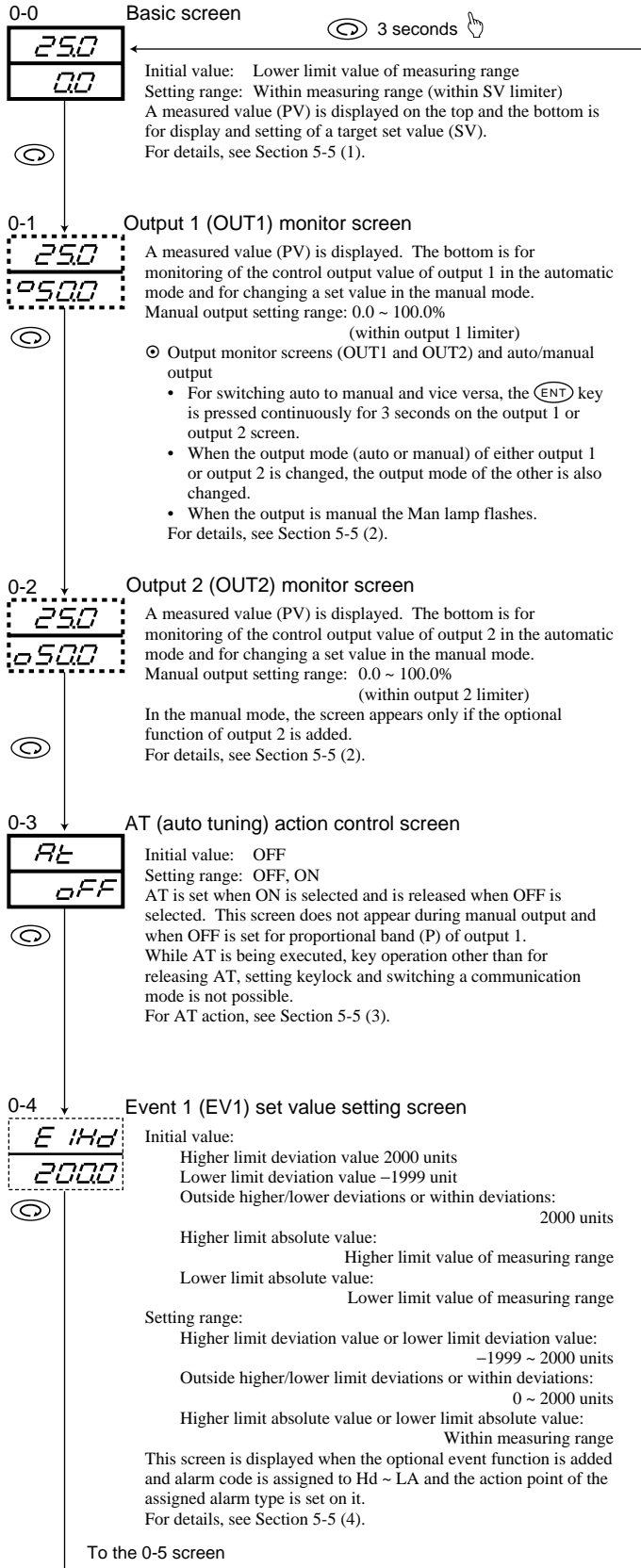

5-7. Explanation of Screen Group 1 and Setting

Screen Group 1

To the 1-2 screen

Key operation:

The key is used to proceed to the next screen. The key and the key are used for selection on each setting screen and the key is used for registration. When the key is pressed while the key is being pressed, the preceding setting screen is called back.

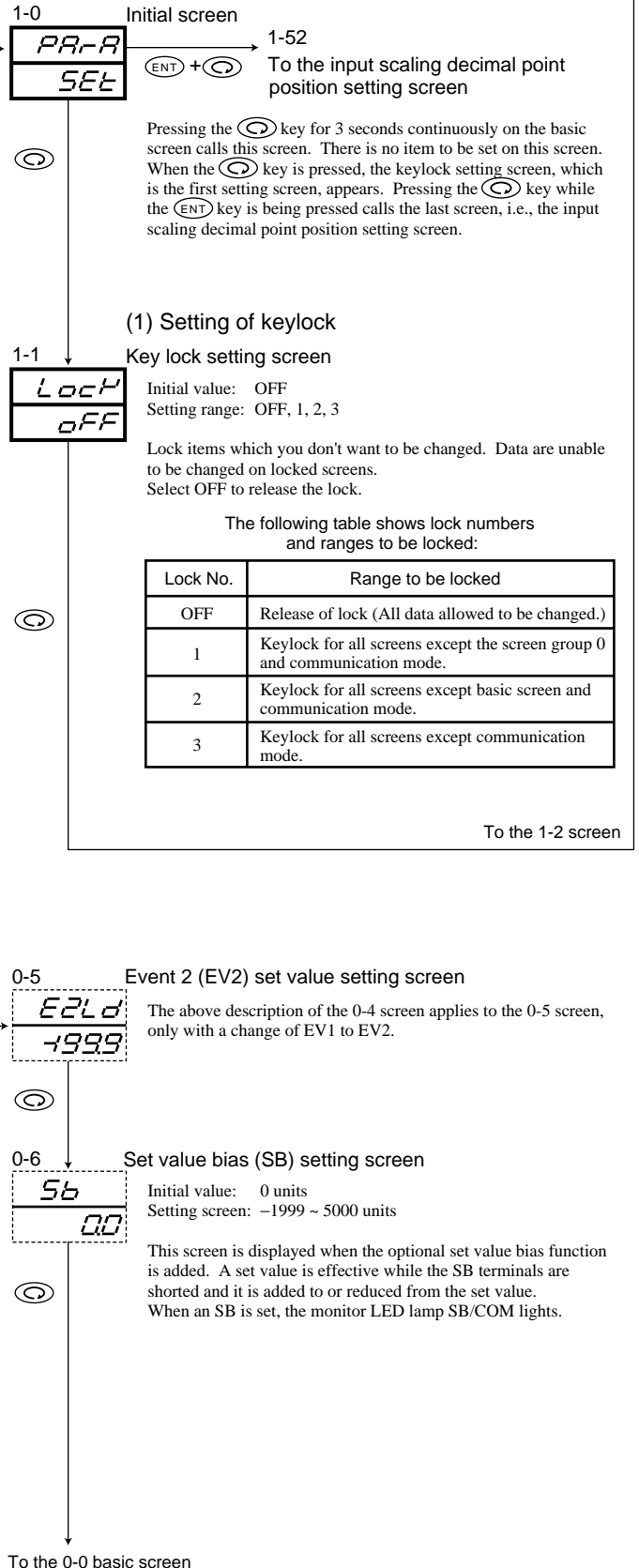

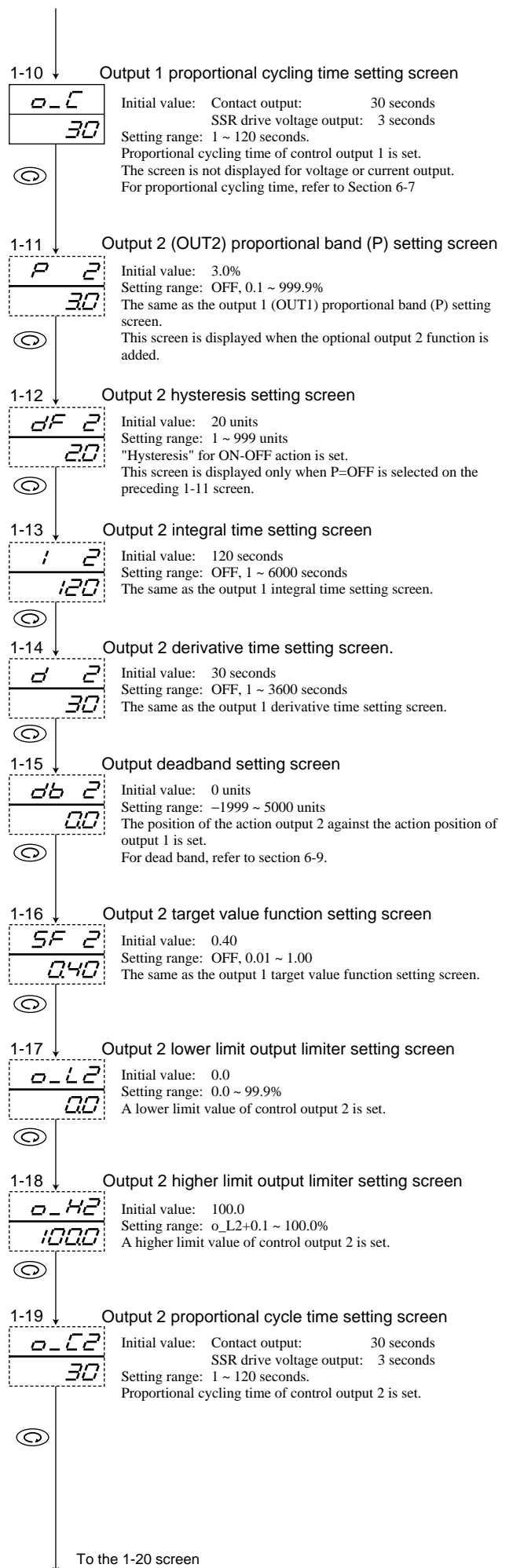
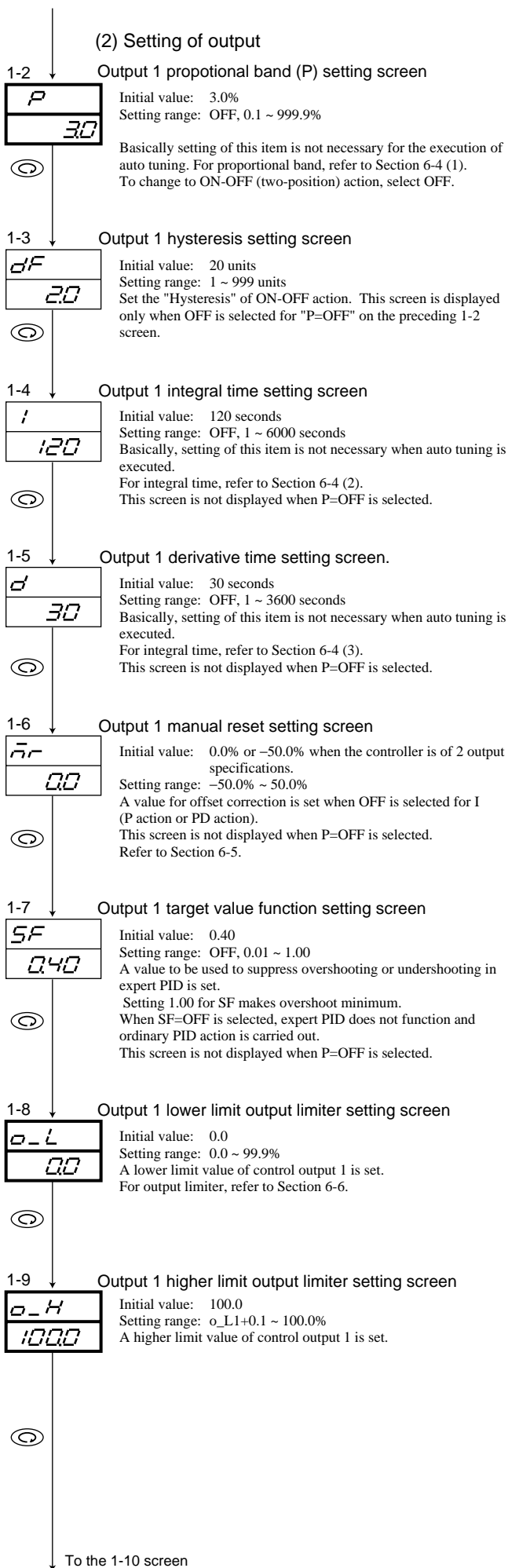

(3) Setting of events

Please refer to section 6-1, 6-2 and 6-3.

1-20 Event 1 type code setting screen

E1 \bar{n}
Hd

Initial value: Hd
Setting range: OFF, Hd, Ld, od, id, HA, LA, So, Hb
The type of event to be selected as event 1 is selected from the following code table.

Table of Event Type (Alarm Type) Codes

| Code | Type of event | Remarks |
|------------|---------------------------------------|--|
| oFF | No selection | |
| Hd | Higher limit deviation | Initial value of event 1 |
| Ld | Lower limit deviation | Initial value of event 2 |
| od | Outside higher/lower limit deviations | |
| $\bar{c}d$ | Within higher/lower limit deviations | |
| HA | Higher limit absolute value | |
| LA | Lower limit absolute value | |
| So | Scaleover | Standby action is invalid. |
| Hb | Heater break/loop alarm | Displayed only when the option is added. |

1-21 Event 1 hysteresis setting screen

E1 \bar{d}
05

Initial value: 5 units
Setting range: 1 ~ 999 units
ON-OFF hysteresis is set for event 1.
This screen is displayed when an alarm type code is selected from **Hd**, **Ld**, **od**, **$\bar{c}d$** , **HA**, **LA**.

1-22 Event 1 standby action code setting screen

E1 \bar{c}
1

Initial value: 1
Setting range: 1, 2, 3, 4
An event 1 standby action type code is selected from the following table.
This screen is displayed when an alarm type code is selected from **Hd**, **Ld**, **od**, **$\bar{c}d$** , **HA**, **LA**.

Table of Standby Action Codes

| Code | Description |
|------|--|
| 1 | Without standby function |
| 2 | Standby action only when power is applied. |
| 3 | Stand-by action when power is applied and when SV in execution is changed. |
| 4 | Control mode (without standby) |

1-23 Event 2 type code setting screen

E2 \bar{n}
Ld

Initial value: Ld
Setting range: OFF, Hd, Ld, od, id, HA, LA, So, Hb
The type of alarm to be selected as event 2 is selected from the table of codes.

1-24 Event 2 hysteresis setting screen

E2 \bar{d}
05

Initial value: 5 units
Setting range: 1 ~ 999 units
ON-OFF hysteresis is set for event 2.
This screen is displayed when an alarm type code is selected from **Hd**, **Ld**, **od**, **$\bar{c}d$** , **HA**, **LA**.

1-25 Event 2 standby action code setting screen

E2 \bar{c}
1

Initial value: 1
Setting range: 1, 2, 3, 4
An event 2 standby action type code is selected from the following table.
This screen is displayed when an alarm type code is selected from **Hd**, **Ld**, **od**, **$\bar{c}d$** , **HA**, **LA**.

To the 1-26 screen

(4) Heater current monitor screen

1-26
Hb \bar{A}
100

Heater current monitor screen
This screen is displayed when the optional heater break/loop alarm function is added and used to monitor heater current. (There is no item to be set on this screen.)

Note:

Heater break/loop alarm works on output 1.
Heater break/loop alarm is selectable as event 1 or event 2.
Heater break/loop alarm is assignable in case output 1 is of contact or SSR drive voltage.

As this screen is for monitoring only, auto return does not function.

(5) Setting of heater break/loop alarm

1-27
Hb \bar{n}
Lc

Heater break/loop alarm action setting screen

Initial value: **Lc**
Setting range: **Lc**, **rE**

Lc (Lock mode): In this mode, once a break or loop alarm is output, the alarm output is maintained until OFF is selected on the heater break or loop alarm value setting screen or the power supply is cut.

rE (Real mode): An alarm is turned ON or OFF according to a rise or fall of the value of current from a set value. The hysteresis for the release of alarm output is fixed to 0.2A.

1-28
Hb \bar{c}
oFF

Heater break/loop standby action setting screen

Initial value: OFF
Setting range: OFF, ON

When ON is set, alarm output is withheld or kept to be on standby until the current value enters its normal range once even if the current at the time of applying power is such that an alarm should be output.

1-29
Hb \bar{s}
oFF

Heater break alarm value setting screen

Initial value: OFF
Setting range: OFF, 0.1 ~ 50.0A

Heater current is detected by CT while control output is ON. Lower current than a set value of current is taken as abnormal and an alarm is output.

1-30
Hl \bar{s}
oFF

Heater loop alarm value setting screen

Initial value: OFF
Setting range: OFF, 0.1 ~ 50.0A

Heater current is detected by CT while control output is OFF. Higher current than a set value of current is taken as abnormal and an alarm is output.

(6) Setting of analog output type

1-31
Ro \bar{n}
PB

Analog output type setting screen

Initial value: **PB**
Setting range: **PB**, **SV**, **out 1**, **out 2**

An item intended to be output as an analog signal is selected from 4 items: Measured value (PV), target set value (SV), control output 1 (OUT1) and control output 2 (OUT2).

1-32
Ro \bar{L}
00

Analog output scaling lower limit setting screen

Initial value: 0.0 (The lower limit value of setting range for PV and SV and 0.0 for OUT1 and OUT2.)

Setting range: Within measuring range when PV or SV is selected 0.0 ~ 100.0% when OUT1 or OUT2 is selected.

A minimum value (0mV, 4mA or 0V) of analog output signal is set as the lower limit value of scaling for an intended output value.

To the 1-33 screen

1-33 Analog output scaling higher limit setting screen

Ao_H
8000

Initial value: 800.0 (The higher limit value of setting range for PV and SV and 100.0 for OUT1 and OUT2.)
Setting range: Within measuring range when PV or SV is selected 0.0 ~ 100.0% when OUT1 or OUT2 is selected.)

A maximum level (10mV, 20mA or 10V) of analog output signal is set as the higher limit value of scaling for an intended output value.
Inversed scaling of Ao_L>Ao_H is also possible. (H-L=±1 count or above)

The following diagrams show analog output characteristics by scaling:

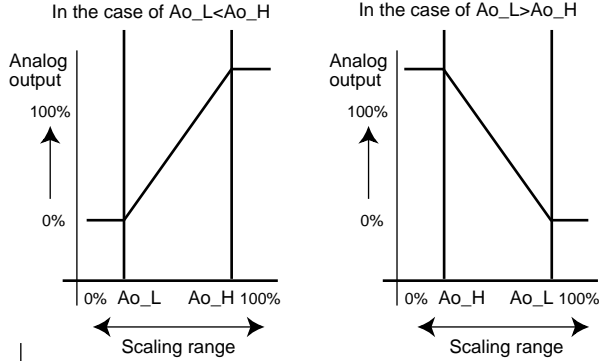

(7) Setting of communication

For the communication function, refer to the Communication Instruction Manual provided separately.

1-34 Communication mode setting screen

com
Loc

Initial value: Loc (local)
Setting range: Loc, Com (com)
Only a change from Com to Loc is possible by operating keys.
Communication is enabled in the mode displayed on the bottom.

1-35 Communication address setting screen

Addr
1

Initial value: 1
Setting range: 1 ~ 255
A machine number is set in case two or more controllers are connected through communication.

1-36 Communication data format setting screen

DATA
7E1

Initial value: 7E1 (Data length 7 bits, even parity, stop bit 1)
Setting range: 7E1, 8N1 (Data length 8 bits, non-parity, stop bit 1)
A communication data format is set.

1-37 Start character setting screen

StxA
Stx

Initial value: Stx
Setting range: Stx, Atx
Which of Stx (STX) and Atx (@) is used as the start character of communication format is set.

1-38 BCC operation type setting screen

bcc
1

Initial value: 1
Setting range: 1 ~ 4
An operation type for error detection BCC check is set from 1 to 4 shown in the following table:

Table of BCC Operation Types

| Type of Operation | Description |
|-------------------|--|
| 1 | Add operation from start character to text end character |
| 2 | 2's complement after add operation from start character to text end character |
| 3 | Exclusive OR operation immediately after start character to text end character |
| 4 | Without BCC operation |

To the 1-39 screen

1-39 Communication speed setting screen

bPS
1200

Initial value: 1200
Setting range: 1200, 2400, 4800, 9600, 19200 bps
A communication speed is set but 19200 bps is displayed as 1920 because of limitation in the number of digits.

1-40 Communication delay time setting screen

dELAY
20

Initial value: 20
Setting range: 1 ~ 100
Time lag from receiving a communication command to transmission is set.
Delay time = Set value × 0.512 msec

1-41 Communication memory mode setting screen

MEM
EEP

Initial value: EEP
Setting range: EEP, RAM, r-E
A mode of writing data in EEPROM and RAM in communication is set.

| Type | Writing Process |
|------|---|
| EEP | Writing entirely in EEPROM |
| r-R | Writing entirely in RAM |
| r-E | Writing OUT1 and OUT2 in RAM and others in EEPROM |

(8) Setting of control output characteristic

1-42 Control output characteristic setting screen

Act
rA

Initial value: rA
Setting range: rA, dA
Characteristic of control output is set.
The following table shows output characteristics of the one-output specification and the two-output specification.

| Output specification | Characteristic | OUT 1 | OUT 2 |
|----------------------|----------------|---------|---------|
| 1 output | RA | Heating | None |
| | DA | Cooling | None |
| 2 output | RA | Heating | Cooling |
| | DA | Heating | Heating |

For control output characteristic, refer to Section 6-9.

(9) Setting of soft start time

1-43 Soft start setting screen

SOFT
OFF

Initial value: OFF
Setting range: OFF, 1 ~ 100 seconds
Soft start time for changing output gradually is set.
Soft start does not function when OFF is set.
For details, see Section 6-10.

(10) Setting of SV limiter

1-44 SV limiter lower limit value setting screen

SV_L
00

Initial value: Lower limit value of measuring range
Setting range: Measuring range lower limit value ~ higher limit value - 1 count
In case a narrower setting range of target value than a measuring range is used, a lower limit value is set.
(It can prevent erroneous setting in a risky range and has some other advantageous effect.)

1-45 SV limiter higher limit value setting screen

SV_H
8000

Initial value: Higher limit value of measuring range
Setting range: Measuring range lower limit value ~ higher limit value + 1 count
In case a narrower setting range of target value than a measuring range is used, a higher limit value is set.
(It can prevent erroneous setting in a risky range and has some other advantageous effect.)

Note:

An SV limiter is set so as to be SV limiter lower limit value < SV limiter higher limit and priority is given to the lower limit value. Therefore, a higher limit cannot be set at a smaller value than a lower limit value + 1 count.

To the 1-46 screen

(11) Setting of PV bias value

1-46 PV bias value setting screen

PV_b
00

Initial value: 0 unit
Setting range: -1999 ~ 2000 units
This value is used to correct an input error from a sensor or the like.
When a bias is used, control is also carried out with a corrected value.

(12) Setting of PV filter time

1-47 PV filter time setting screen

PV_F
0

Initial value: 0 second
Setting range: 0 ~ 100 seconds
In case input changes conspicuously or noise continues, PV filter is used to mitigate such undesirable effect.
When 0 second is set, filter does not function.

(13) Setting of measuring range code

1-48 Measuring range code setting screen

rAnG
05

Initial value: Multi 05, voltage 86, current 92
Setting range: Select from the Table of Measuring Range Codes in Section 5-8
Each code represents a combination of an input type and a measuring range.

(14) Setting of temperature unit

1-49 Temperature unit setting screen

Unit
C

Initial value: C
Setting range: C, F
Select C (°C) or F (°F) as the unit of temperature for sensor input.
This screen is not displayed when linear input (mV, V or mA) is selected.

(15) Setting of input scaling

1-50 Input scaling lower limit value setting screen

Sc_L
00

Initial value: 0.0
Setting range: -1999 ~ 9989 units
A lower limit value of scaling of linear input (mV, V or mA) is set. The screen is for monitoring only for sensor input and setting is not possible.

1-51 Input scaling higher limit value setting screen

Sc_H
1000

Initial value: 100.0
Setting range: Sc_L + 10 ~ Sc_L + 5000
A higher limit value of scaling of linear input (mV, V or mA) is set. For sensor input, the screen is for monitoring only and setting is not possible.

Note:
If input scaling higher/lower limits is set to make difference between the higher and lower limit values less than + 10 counts or more than +5000 counts, the higher limit value is automatically changed to make the difference +10 counts or +5000 counts.
A higher limit value which is smaller than a lower limit value + 10 counts or larger than a lower limit value + 5000 counts is unable to be set.

1-52 Input scaling decimal point position setting screen

ScdP
00

Initial value: 1 digit on the right of decimal point (0.0)
Setting range: No decimal point (0) ~ 3 digits on the right of decimal point (0.000)
The position of decimal point for input scaling is set. For sensor input, this screen is for monitoring only and setting is not possible.

ENT +

From the 1-0 initial screen of the screen group 1

To the 1-0 initial screen of the screen group 1

5-8. Table of measuring range codes

Select a measuring range from the following table.
A change of the code will initialize all data related to the measuring range.

Table of Measuring Range Codes

| Input type | | Code | Measuring range (°C) | Measuring range (°F) |
|-------------|---------------|--|--|----------------------|
| Multi-input | Thermocouple | B *1 01 | 0 ~ 1800 | 0 ~ 3300 |
| | | R 02 | 0 ~ 1700 | 0 ~ 3100 |
| | | S 03 | 0 ~ 1700 | 0 ~ 3100 |
| | | K 04 *2 | -199.9 ~ 400.0 | -300 ~ 750 |
| | | | 0.0 ~ 800.0 | 0 ~ 1500 |
| | | | 0 ~ 1200 | 0 ~ 2200 |
| | | E 07 | 0 ~ 700 | 0 ~ 1300 |
| | | J 08 | 0 ~ 600 | 0 ~ 1100 |
| | | T 09 *2 | -199.9 ~ 200.0 | -300 ~ 400 |
| | | N 10 | 0 ~ 1300 | 0 ~ 2300 |
| | PLII *3 11 | 0 ~ 1300 | 0 ~ 2300 | |
| | Wre5-26 *4 12 | 0 ~ 2300 | 0 ~ 4200 | |
| | U *5 13 *2 | -199.9 ~ 200.0 | -300 ~ 400 | |
| | | L *5 14 | 0 ~ 600 | 0 ~ 1100 |
| R.T.D. | Pt100 | 31 | -200 ~ 600 | -300 ~ 1100 |
| | | 32 | -100.0 ~ 100.0 | -150.0 ~ 200.0 |
| | | 33 | -50.0 ~ 50.0 | -50.0 ~ 120.0 |
| | | 34 | 0.0 ~ 200.0 | 0.0 ~ 400.0 |
| | JPt100 | 35 | -200 ~ 500 | -300 ~ 1000 |
| | | 36 | -100.0 ~ 100.0 | -150.0 ~ 200.0 |
| | | 37 | -50.0 ~ 50.0 | -50.0 ~ 120.0 |
| | | 38 | 0.0 ~ 200.0 | 0.0 ~ 400.0 |
| mV | -10~10mV 71 | Initial value: 0.0 ~ 100.0 Input scaling measuring range: -1999 ~ 9999 Span: 10 ~ 5000 counts Position of decimal point: None 1, 2 or 3 digits on the right of decimal point | | |
| | 0~10mV 72 | | | |
| | 0~20mV 73 | | | |
| | 0~50mV 74 | | | |
| | 10~50mV 75 | | | |
| | 0~100mV 76 | | | |
| Voltage | V | -1~1V 81 | Initial value: 0.0 ~ 100.0 Input scaling measuring range: -1999 ~ 9999 Span: 10 ~ 5000 counts Position of decimal point: None 1, 2 or 3 digits on the right of decimal point | |
| | | 0~1V 82 | | |
| | | 0~2V 83 | | |
| | | 0~5V 84 | | |
| | | 1~5V 85 | | |
| | | 0~10V 86 | | |
| Current | mA | 0~20mA 91 | | |
| | | 4~20mA 92 | | |

Thermocouple B, R, S, K, E, J, T, N: JIS/IEC

R.T.D. Pt100: JIS/IEC

JPt100: Former JIS

*1 Thermocouple B: Accuracy guarantee not applicable to 400°C (752°F) and below.

*2 Thermocouple K, T, U: Accuracy of those whose readings are below -100°C is ±0.7% FS

*3 Thermocouple PLII: Platinel

*4 Thermocouple Wre5-26: A product of Hoskins

*5 Thermocouple U, L: DIN 43710

NOTE: Unless otherwise specified, the measuring range will be set as listed below during the shipment from the factory.

| Input | Specification/Rating | Measuring range |
|--------------|----------------------|-----------------|
| Multi-input | K thermocouple | 0.0 ~ 800.0°C |
| Voltage (V) | 0 ~ 10V DC | 0.0 ~ 100.0 |
| Current (mA) | 4 ~ 20mA DC | 0.0 ~ 100.0 |

6. Explanation of Functions

(All the details are mentioned here except the explanation of 5-5. Procedure of setting screen group 0)

6-1. Events

1) Deviation Alarm

An alarm action point is set by a deviation from target set value (SV). For example, when the target set value is 20°C, +10°C should be set for higher limit deviation alarm in order to put an alarm in action at 30°C and higher. To put an alarm in action at 30°C and lower when the target set value is 100°C, -70°C should be set for higher limit deviation alarm. Higher limit deviation alarm must be higher than the target set value and lower limit deviation alarm must be lower than the target set value. This is conveniently used to make the alarm action point follow deviation from the target set value. The set range will be -1999~2000 unit.

2) Absolute Value Alarm

An alarm action point is set by an absolute value. For example, when the target set value is 20°C, 30°C should be set for higher limit absolute alarm in order to put an alarm in action at 30°C and higher. To put an alarm in action at 30°C and lower when the target set value is 100°C, 30°C should be set for lower limit absolute alarm. Both higher limit and lower limit can be set at any value within the measuring range.

This alarm is convenient when the alarm action point is fixed.

3) Standby Action

This is used to withhold alarm action even when an alarm action point is reached when power is applied and to put the alarm in action on the alarm action point after a target set value (SV) is reached.

4) No-standby Action

If an alarm action point is reached when power is applied, an alarm is output. This is used to output an alarm whenever an alarm action point is reached.

6-2. Setting of Event Standby Action

In the 1-22 event 1 standby action code setting screen in the explanation of the screen group 1:

- 1) Select a code from 1, 2 and 3 of the standby action code table when event output is used as an alarm;
- 2) Select 4 when event output is used for control. Note, however, that setting 4 will turn event output OFF if input goes out of order;
- 3) When 2 is set, the standby function is put in action only when power is applied;
- 4) When 3 is set, the standby function is put in action when power is applied and when SV in execution is changed.
- 5) A change to 1 or 4 while standby action is in execution, the standby action will be released immediately;
- 6) If a PV value is out of a range in which an event action is ON, standby action becomes invalid even when 2 or 3 has been set for standby action. The 1-25 event 2 standby action code setting screen is the same.

6-3. Alarm Action Diagrams

The following are diagrams showing alarm actions that can be selected as event 1 and event 2.

Hd : Higher limit deviation alarm

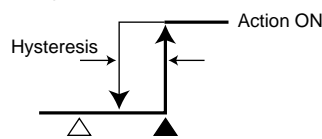

Ld : Lower limit deviation alarm

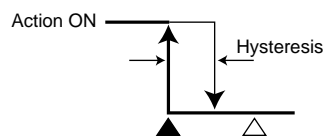

\triangle : SV value \blacktriangle : Alarm action point

Od : Outside higher/lower limit deviations alarm

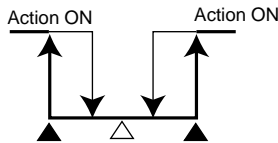

Wd : Within higher/lower limit deviations alarm

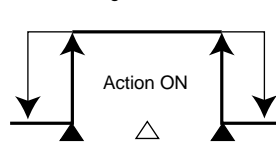

HA : Higher limit absolute value alarm

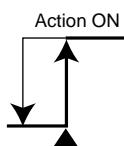

LA : Lower limit absolute value alarm

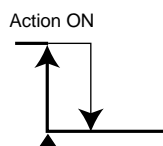

So : Scaleover

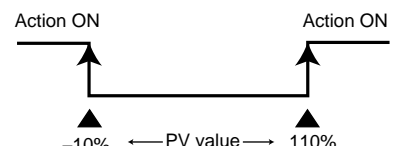

6-4. P.I.D.

1) P (Proportional action)

A percentage at which control output varies with respect to a measuring range is set. Control output increases or decreases in proportion to a difference between PV and SV values. The narrower the proportional band, the more conspicuously output changes to strengthen proportional action. If it is too narrow, however, the result of control will be close to ON-OFF action.

2) I (Integral time)

This is the function to correct an offset (constant deviation). The longer the integral time, the weaker the corrective action and the shorter the time the stronger the action but control result may be undulated due to integral hunting.

3) D (Derivative time)

This is the function to estimate a change in control output, suppress overshoot caused by integration and improve control stability. The longer the derivative time, the stronger the derivative action but control result may be vibratile.

6-5. Manual Reset

In PID action, an offset is corrected automatically by I, i.e., integration. When OFF is set for I, correction is not carried out and so output should be increased or decreased manually. This method is called manual reset.

6-6. Lower Limit and Higher Limit Setting Limiters

- 1) Output limiter means to limit a minimum or maximum value of control output and this function is effective in maintaining the lowest temperature or suppressing overshooting of control.
- 2) Output limiter gives preference to a lower limit value. When a larger lower limit value than a higher limit value is set, the higher limit value is automatically changed to the lower limit value + 1%. In other words, it is not possible to set a higher limit value which is less than a lower limit + 1%.

6-7. Proportional Cycling Time

It should be within a range from 1~120 seconds in the case of contact output or SSR drive voltage output. Proportional cycling time is ON time + OFF time within a proportional band.

6-8. Auto Return Function

If no key is operated for 3 minutes or longer on a screen (except the 0-1 output 1 monitor screen, 0-2 output 2 monitor screen and 1-26 heater current monitor screen), the screen automatically changes to the 0-0 basic screen of the mode 0 screen group. This is called auto return.

6-9. Control Output Characteristics

1) One output

For heating action, RA (reverse action) OUT 1 is set, and for cooling action DA (direct action) OUT 1 is set.

2) Two outputs

- ① RA (reverse action) is set for heating action OUT1 and cooling action OUT2.
- ② DA (direct action) is set for heating action OUT1 and heating action OUT2.

Control output characteristics with two outputs are shown in the following diagrams. ① shows heating and cooling control and ② two-stage heating control.

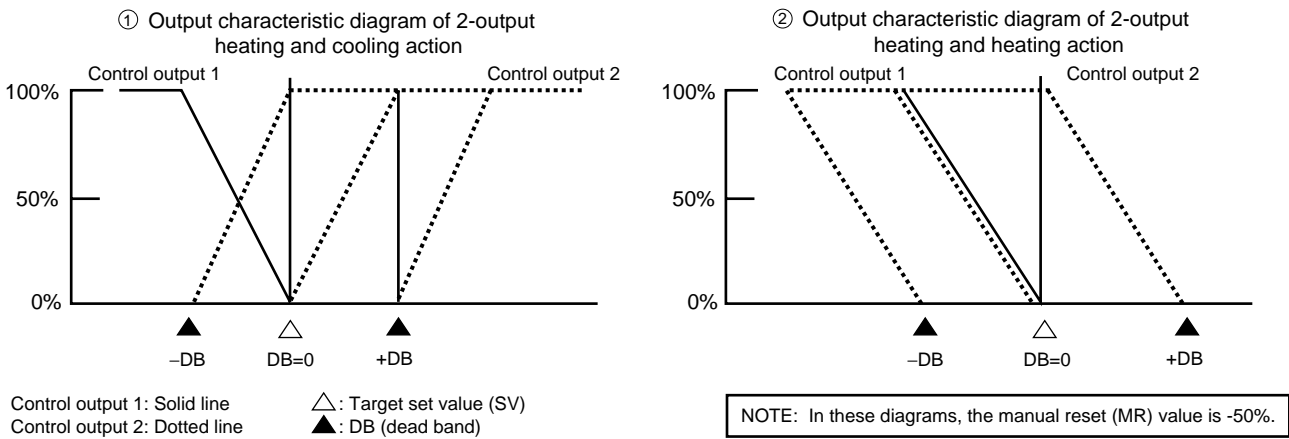

6-10. Soft Start

It is the function to raise control output gradually in a set time upon applying power and at the time of return from scaleover to normal. The function effectively prevents excess current from being present in a heater or the like.

1) The soft start function is put in action in the following conditions:

- ① When power is applied in the automatic output mode and when a normal state is returned from scaleover.
- ② When P (proportional band) is not OFF.
- ③ When soft start time has been set, i.e., not OFF.

2) Soft start is released in the following conditions:

- ① Soft start time has elapsed normally.
- ② An output value under soft start control exceeds an PID operated output value.
- ③ Soft start time is turned OFF by key operation.
- ④ The automatic output mode is changed to the manual output mode by key operation.
- ⑤ AT (auto tuning) is executed by key operation.
- ⑥ The setting of P (proportional band) is changed to OFF by key operation.
- ⑦ The measuring range of input is changed by key operation.
- ⑧ A control output characteristic is changed by key operation.

7. Maintenance and Troubleshooting

7-1. Procedure of Maintenance Replacement and Matters to Be Attended to (Steps for replacing defective items)

- ① **Confirmation of Model Code:**
Check the model code of the component part in trouble. (Open the control box, and you can find an appropriate code in the model label affixed to the instrument case.)
- ② **Inquiry on Input Data:**
Ask the manufacturer if input data (control date of external operation, event output, set value of position, etc. at the time when an error occurs) is necessary or not.
- ③ **Confirmation of Present Wiring Condition:**
Check and record the present wiring condition. Please note that in case input data is necessary for control, the same control operation as before is not possible with a replaced product unless such data is input.
- ④ **Confirmation of Present Input Data:**
When data is not known, call the input data for the product, check and record it. In case input data is required, the same control operation as before is not possible with a replaced product unless such data is input.
- ⑤ **Repair of Present Product or Procurement of New Product:**
In case the product in trouble is removable from the site of installation, remove and have it repaired. If it is not possible, arrange to acquire a new product for replacement.
- ⑥ **Setting before Starting Operation:**
When replaced by a new product, check the wiring, apply power and set items as described in 5-4. Before Starting Up.

7-2. Cause of Trouble and Troubleshooting

| Problem | Cause | Remedy |
|--|---|---|
| ① Error code is displayed. | Refer to "Error Codes, Causes and Remedies." | Refer to "Error Codes, Causes and Remedies." |
| ② Displayed PV value seems to be incorrect. | <ol style="list-style-type: none"> ① Set measuring range code is different from that of input sensor/input signal. ② Erroneous wiring to input terminals of sensor | <ol style="list-style-type: none"> ① Check if set measuring range code is correct for input signal. ② Correct wiring to input terminals of sensor. |
| ③ Display on the front panel goes out and the instrument does not operate. | <ol style="list-style-type: none"> ① Problem with power supply and wiring connection. ② Deterioration of the product. | <ol style="list-style-type: none"> ① Inspect portions related to power source and wire connection. Check wiring. ② Examine the product and repair or replace. |
| ④ Key unable to be operated. | <ol style="list-style-type: none"> ① Keylock is in effect. ② Deterioration of the product. ③ In case communication function is added, the communication mode (Com) has been set. | <ol style="list-style-type: none"> ① Release keylock. ② Examine and repair or replace the product. ③ Change the communication setting to the local mode (Loc). |
| ⑤ ON-OFF action of control output is too fast. | <ol style="list-style-type: none"> ① ON-OFF is set for P of PID. ② Too small a value set for hysteresis of ON-OFF action. | <ol style="list-style-type: none"> ① Change the OFF set for P to two-position type ON-OFF action. ② Increase the hysteresis value of ON-OFF action. |

7-3. Error Codes, Causes and Remedies

(1) Input measured value problems

| Screen display | Problem | Cause | Remedy |
|-----------------------|--|---|--|
| <i>HHHH</i> (HHHH) | Higher limit side scaleover | <ul style="list-style-type: none"> ① A break of thermocouple input wiring ② A break of R.T.D. input A wiring ③ Input measured value exceeded higher limit of measuring range by 10%. | <ul style="list-style-type: none"> ① Check thermocouple input wiring for a possible break. ② Check R.T.D. input A wiring for a possible break. If wiring has no problem, replace R.T.D. ③ For voltage or current input, check the transmitting unit of measured values. Check if set code of measuring range is correct for input signal. |
| <i>LLLL</i> (LLLL) | Lower limit side scale over | Input measured value fell from lower limit of measuring range by 10%. | Check wiring of inversed polarity for measured value input. |
| <i>b---</i> (b---) | A break of R.T.D. input wiring. | <ul style="list-style-type: none"> ① A break of B ② Breaks of ABB | Check R.T.D. input terminals A, B and B for breaks. If wiring has no problem, replace R.T.D. |
| <i>CJHH</i> (CJHH) | Higher limit side scaleover of reference contact (CJ) of thermocouple input. | Ambient temperature of the product has exceeded 80°C. | <ul style="list-style-type: none"> ① Reduce ambient temperature to the level provided in the environment conditions for the product. ② In case ambient temperature has not exceeded 80°C, examine the SR90. |
| <i>CJLL</i> (CJLL) | Lower limit side scaleover of reference contact (CJ) of thermocouple input. | Ambient temperature of the product has fallen to -20°C or lower. | <ul style="list-style-type: none"> ① Raise ambient temperature to the level provided in the environment conditions for the product. ② In case ambient temperature has not fallen to -20°C, examine the product. |

(2) Heater break/loop alarm problems

| Screen display | Problem | Cause | Remedy |
|-----------------------|---|------------------------|---|
| <i>HbHH</i> (HBHH) | Input value from heater current detector has exceeded 55.0A. | Excess current | <ul style="list-style-type: none"> ① Reduce the current. ② Examine the product. |
| <i>HbLL</i> (HBLL) | Input value from heater current detector fails to reached 5.0A. | The product in trouble | Examine, repair or replace the product. |

8. Record of Parameter Setting (For convenience sake, recording set values and selected items is recommended.)
The initial values are of Code 05 (K).

| Screen No. | Parameter (Item)/screen display | Initial value | Setting/Selection | Record |
|------------|--------------------------------------|--------------------|--|----------------|
| 0-0 | Basic screen | 0 (0) | 0 | |
| 0-1 | Output 1 monitor | | | |
| 0-2 | Output 2 monitor | | | |
| 0-3 | AT action | At. (At) | oFF | |
| 0-4 | Event 1 set value setting | E1Hd. (E1Hd) | 2000 units | |
| 0-5 | Event 2 set value setting | E2Hd. (E2Hd) | -1999 units | |
| 0-6 | Set value bias setting | Sb. (Sb) | 0 units | |
| 1-0 | Initial screen | PArA. (PArA) | SEt | |
| 1-1 | Keylock setting | KLc. (PLc) | oFF | |
| 1-2 | Output 1 proportional band setting | P. (P) | 30 | |
| 1-3 | Output 1 hysteresis | dF. (dF) | 20 units | |
| 1-4 | Output 1 integral time | I. (I) | 120 | |
| 1-5 | Output 1 derivative time | d. (d) | 30 | |
| 1-6 | Output 1 manual reset | mr. (nr) | 00 | |
| 1-7 | Output 1 target value function | SF. (SF) | 0.40 | |
| 1-8 | Output 1 lower limit output limiter | o-L. (o_L) | 00 | |
| 1-9 | Output 1 higher limit output limiter | o-H. (o_H) | 1000 | |
| 1-10 | Output 1 proportional cycling time | o-C. (o_C) | Y: 30, P: 3 | |
| 1-11 | Output 2 proportional band setting | P2. (P2) | 30 | |
| 1-12 | Output 2 hysteresis | dF2. (dF2) | 20 units | |
| 1-13 | Output 2 integral time | I2. (I2) | 120 | |
| 1-14 | Output 2 derivative time | d2. (d2) | 30 | |
| 1-15 | Output dead band | db2. (db2) | 0 units | |
| 1-16 | Output 2 target value function | SF2. (SF2) | 0.40 | |
| 1-17 | Output 2 lower limit output limiter | o-L2. (o_L2) | 00 | |
| 1-18 | Output 2 higher limit output limiter | o-H2. (o_H2) | 1000 | |
| 1-19 | Output 2 proportional cycling time | o-C2. (o_C2) | Y: 30, P: 3 | |
| 1-20 | Event 1 type | E1-m. (E1_n) | Hd | |
| 1-21 | Event 1 hysteresis | E1-d. (E1_d) | 5 units | |
| 1-22 | Event 1 standby action | E1-i. (E1_c) | 1 | |
| 1-23 | Event 2 type | E2-m. (E2_n) | Ld | |
| 1-24 | Event 2 hysteresis | E2-d. (E2_d) | 5 units | |
| 1-25 | Event 2 standby action | E2-i. (E2_c) | 1 | |
| 1-26 | Heater current monitor | Hb-A. (Hb_A) | | |
| 1-27 | Heater break/loop alarm | Hb-m. (Hb_n) | Lc | |
| 1-28 | Heater break/loop alarm standby | Hb-i. (Hb_c) | oFF | |
| 1-29 | Heater break alarm value | Hb-S. (Hb_S) | oFF | |
| 1-30 | Heater loop alarm value | HL-S. (HL_S) | oFF | |
| 1-31 | Analog output type | Ao-m. (Ao_n) | Pd | |
| 1-32 | Analog output scaling lower limit | Ao-L. (Ao_L) | 00 | |
| 1-33 | Analog output scaling higher limit | Ao-H. (Ao_H) | 8000 | |
| 1-34 | Communication mode setting | comm. (com_n) | Loc | |
| 1-35 | Communication address | Addr. (Addr) | 1 | |
| 1-36 | Communication data format | dAtA. (dAtA) | 7E1 | |
| 1-37 | Start character | SchA. (SchA) | 5E4 | |
| 1-38 | BCC operation type | bcc. (bcc) | 1 | |
| 1-39 | Communication speed | bPS. (bPS) | 1200 | |
| 1-40 | Communication delay time | dely. (dELY) | 20 | |
| 1-41 | Communication memory mode | mem. (mem_n) | EEP | |
| 1-42 | Control output characteristic | Act. (Act) | rA | |
| 1-43 | Soft start time | Soft. (Soft) | oFF | |
| 1-44 | SV limiter lower limit value | SV-L. (SV_L) | 00 | |
| 1-45 | SV limiter higher limit value | SV-H. (SV_H) | 8000 | |
| 1-46 | PV bias value | PV-b. (PV_b) | 0 units | |
| 1-47 | PV filter time | PV-F. (PV_F) | 0 | |
| 1-48 | Measuring range codes | Multi: V: A: | rAnG. (rAnG) rAnG. (rAnG) rAnG. (rAnG) | 05 86 92 |
| 1-49 | Temperature unit | Unit. (Unit) | c | |
| 1-50 | Input scaling lower limit | Sc-L. (Sc_L) | 00 | |
| 1-51 | Input scaling higher limit | Sc-H. (Sc_H) | 8000 | |
| 1-52 | Input scaling decimal point position | Scdp. (ScdP) | 00 | |

9. Specifications

■ Display

- Digital display: Measured value (PV)/7 segments red LED 4 digits
Target set value (SV)/7 segments green LED 4 digits
- Display accuracy: $\pm(0.3\%FS + 1 \text{ digit})$
Excluding reference contact temperature compensation accuracy of thermocouple input.
Accuracy of readings lower than $-100^{\circ}C$ of thermocouples K, T, U inputs is $\pm 0.7\%FS$.
Accuracy guarantee not applicable to $400^{\circ}C$ ($752^{\circ}F$) and below of B thermocouple.
- Display accuracy maintaining range: $23^{\circ}C \pm 5^{\circ}C$ ($18\sim 28^{\circ}C$)
- Display resolution: Differs by measuring range (0.001, 0.01, 0.1 and 1)
- Measured value display range: $-10\% \sim 110\%$ of measuring range
- Display updating cycle: 0.25 seconds
- Action display/color: 7 type, LED lamp display
Control output (OUT1, OUT2)/Green
Event (EV1, EV2)/Orange
Auto tuning/Green
Manual control output (MAN)/Green
Set value bias, communication (SB/COM)/Green

■ Setting

- Setting method: By operating 4 keys (\odot , \blacktriangle , \blacktriangledown and ENT) on the front panel
- Target value setting range: Same as measuring range (within setting limiter)
- Setting limiter: Individual setting for higher and lower limits, any value is selectable within measuring range (Lower limit value < Higher limit value)

■ Input

- Type of input: Selectable from multiple (TC, Pt, mV), voltage (V) and current (mA)
- Thermocouple: B, R, S, K, E, J, T, N, PL II, Wre5-26 (UL (DIN 43710))
Input impedance: 500k Ω minimum
External resistance tolerance: below 100 Ω
Burnout function: Standard feature (up scale)
Reference contact compensation accuracy: $\pm 1^{\circ}C$ (within the accuracy maintaining range ($23 \pm 5^{\circ}C$))
 $\pm 2^{\circ}C$ (between 5 and $45^{\circ}C$ of ambient temperature)
- R.T.D.: Pt100/JPt100, 3-wire type
Normal current: 0.25 mA
Lead wire tolerance: 5 Ω maximum/wire (3 lead wires should have the same resistance.)
- Voltage mV: $-10\sim 10, 0\sim 10, 0\sim 20, 0\sim 50, 10\sim 50, 0\sim 100$ mV DC
V: $-1\sim 1, 0\sim 1, 0\sim 2, 0\sim 5, 1\sim 5, 0\sim 10$
Input impedance: over 500k Ω
- Current mA: $0\sim 20, 4\sim 20$ mA DC
Receiving impedance: 250 Ω
- Input scaling function: Scaling possible for voltage (mV, V) or current (mA) input
Scaling range: $-1999\sim 9999$ counts
Span: $10\sim 5000$ counts
Position of decimal point: None, 1, 2 and 3 digits on the right of decimal point
- Sampling cycle: 0.25 seconds
- PV bias: $-1999\sim 2000$ units
- PV filter: $0\sim 100$ seconds
- Isolation: Control input not insulated from system, set value bias, and CT input but insulated from others

■ Control

- Control mode
With 1 output: Expert PID control with auto tuning function
RA (reverse characteristic): Heating action
DA (direct characteristic): Cooling action
With 2 outputs: Expert PID control with auto tuning function + PID control

RA (reverse characteristic): Heating action (OUT1) and cooling action (OUT2)

DA (direct characteristic): 2-stage heating action

- Type of control/rating: Contact/1 a 240V AC 2A (resistive load) 1.2A (inductive load)
(Common to Output 1 and 2): SSR drive voltage/12V ± 1.5 V DC (Maximum load current 30mA)
Current/4~20mA DC (Maximum load resistance 600 Ω)
Voltage/0~10V DC (Maximum load current 2mA)
- Control output resolution: Control output 1: approx. 0.0125% (1/8000)
Control output 2: approx. 0.5% (1/200)
- Control output 1
Proportional band (P): OFF, 0.1~999.9% (ON-OFF action by OFF)
Integral time (I): OFF, 1~6000 seconds (P or PD action by OFF)
Derivative time (D): OFF, 1~3600 seconds (P or PI action by OFF)
Target value function: OFF, 0.01~1.00
ON-OFF hysteresis: 1~999 units (Effective when P=OFF)
Manual reset: $-50.0\sim 50.0\%$ (Effective when I=OFF)
Higher/lower limit output limiter: Lower limit 0.0~99.9%, higher limit 0.1~100.0% (Lower limit value < Higher limit value)
Proportional cycle: 1~120 seconds (for contact and SSR drive voltage output)
- Control output 2 (option)
Proportional band (P): OFF, 0.1~999.9% (ON-OFF action by OFF)
Integral time (I): OFF, 1~6000 seconds (P or PD action by OFF)
Derivative time (D): OFF, 1~3600 seconds (P or PI action by OFF)
Target value function: OFF, 0.01~1.00
ON-OFF hysteresis: 1~999 units (Effective when P=OFF)
Dead band: $-1999\sim 5000$ units (Overlap with a negative value)
Higher/lower limit output limiter: Lower limit 0.0~99.9%, higher limit 0.1~100.0% (Lower limit value < Higher limit value)
Proportional cycle: 1~120 seconds (for contact and SSR drive voltage output)
- Manual control
Output setting range: 0.0~100.0%
Setting resolution: 0.1%
Manual \leftrightarrow auto switching: Balanceless bumpless (within proportional range, however.)
- Soft start: OFF, 1~100 seconds
- AT point: SV value in execution
- Control output characteristic: RA (reverse characteristic)/DA (direct characteristic) switching by front key
Contact output isolated from all.
Analog output not insulated from SSR drive voltage, current and voltage but insulated from others. (In case another output is also of SSR drive voltage, current or voltage, however, two outputs are not insulated from each other.)
- Isolation:
- Event output (option)
● Number of event points: 2 points of EV1 and EV2
● Types: Selectable from the following 9 types for EV1 and EV2:
OFF: No selection
Hd: Higher limit deviation
Ld: Lower limit deviation
od: Outside higher/lower limit deviations
ld: Within higher/lower limit deviations
HA: Higher limit absolute value
LA: Lower limit absolute value
So: Scaleover
Hb: Heater break/loop alarm
- Event setting range: Absolute values (both higher limit and lower limit): Within measuring range
Deviations (both higher limit and lower limit): $-1999\sim 2000$ units
Higher/lower limit deviations (within/outside): $0\sim 2000$ units
- Event action: ON-OFF action

- Hysteresis: 1~999 units
- Standby action: Selectable from the following 4 types for EV1 and EV2:
 - 1 Without standby action.
 - 2 Standby when power is applied.
 - 3 Standby when power is applied and when SV value in execution is changed.
 - 4 Control mode without standby action (No alarm is output at the time of abnormal input).
- Output type/rating: Contact (1a × 2 points common)/240V AC 1A (resistive load)
- Output updating cycle: 0.25 seconds
- **Heater break/heater loop alarm (option)**
Break/loop detection only for OUT1 (Selectable when output type is contact or SSR drive voltage)
- Current capacity: 30A, 50A to be designated when CT is ordered.
- Alarm action: Heater current is detected by external CT provided as an accessory.
When heater break is detected while control output is ON=Alarm output ON
When heater loop alarm is detected while control output is OFF=Alarm output ON
- Current setting range: OFF, 0.1~50.0A (Alarm action is stopped by setting OFF)
- Setting resolution: 0.1A
- Current display range: 0.0~55.0A
- Display accuracy: ±2.0A (Sine wave at 50Hz)
- Minimum time to identify action: 0.25 seconds (every 0.5 seconds) common to ON and OFF
- Alarm retention mode: Selectable from lock (to retain) and real (not to retain).
- Standby action: Selectable from without (OFF) and with (ON).
- Sampling cycle: 0.5 seconds
- Isolation: CT input not insulated from system and other inputs but insulated from the rest.
- **Set value bias (option)**
- Setting range: -1999~5000 units
- Action input: No-voltage contact or open collector (level action) about 5V DC, 1mA maximum
- Minimum level retention time: 0.15 seconds
- Isolation: Action input not insulated from system and other inputs but insulated from others
- **Communication function (option)**
- Type of communication: RS-232C, RS-485
- Communication system: RS-232C 3-line type half duplex system
RS-485 2-line type half duplex system (RS-485 is of half-duplex multi-drop (bus) system)
- Synchronization system: Start-stop synchronization system
- Communication distance: RS-232C The longest: 15 m
RS-485 The longest 500 m (depending on conditions)
- Communication speed: 1200, 2400, 4800, 9600, 19200 bps
- Data format: 7 bits, even parity, 1 stop bit or 8 bits, non-parity, 1 stop bit
- Communication address: 1~255
- Communication memory mode: EEP/RAM/r_E
- Communication BCC: Add/Add two' S cmp/XOR/None
- Communication delay time: 1~100 (× 0.512 msec)
- Communication code: ASCII code
- Communication protocol: Shimaden's standard protocol
- Number of connectable instruments: RS-232 1
RS-485 up to 31
- Isolation: Communication signals insulated from system, each input and each output.

■ Analog output (option)

- Number of output points: 1 point
- Type of analog output: Selectable from measured value, target value (SV in execution), control output 1 and control output 2.
- Output signal/rating: 4~20mA DC/Maximum load resistance 300Ω
0~10V DC/Maximum load current 2mA
0~10mV DC/Output impedance 10Ω
- Output scaling: Measured value, target value: Within measuring range (inversed scaling possible)
Control output 1 and 2 0.0~100.0% (inversed scaling possible)
- Output accuracy: ±0.3% FS (with respect to displayed value)
- Output resolution: About 0.01% (1/10000)
- Output updating cycle: 0.25 seconds
- Isolation: Analog output insulated from system and inputs but not insulated from control output except contact output.

■ General specifications

- Data storage: Non-volatile memory (EEPROM)
- Environmental conditions for instrument operation:
 - Temperature: -10~50°C
 - Humidity: 90% RH or less (no dew condensation)
 - Height: 2000m from the sea level or lower
 - Category: II
 - Degree of pollution: 2
- Storage temperature: -20~65°C
- Supply voltage: Either 100-240V AC±10% 50/60Hz or 24V AC/DC±10% to be designated.
SR91: 100-240V AC 11VA maximum for AC; 6W for DC 24V; 7VA for AC 24V
SR92, SR93 and SR94: 100-240V AC 15VA maximum for AC; 8W for DC 24V; 9VA for AC 24V
- Power consumption: SR91: 100-240V AC 11VA maximum for AC; 6W for DC 24V; 7VA for AC 24V
SR92, SR93 and SR94: 100-240V AC 15VA maximum for AC; 8W for DC 24V; 9VA for AC 24V
- Input/noise removal ratio: 50 dB or higher in normal mode (50/60 Hz)
130 dB or higher in common mode (50/60 Hz)
- Conformity with standards: Safety: IEC1010 and EN61010-1
EMC: EN61326
- Insulation resistance: Between input/output terminals and power terminal 500V DC 20MΩ or above;
Between input/output terminals and protective conductor terminal 500V DC 20MΩ or above
- Dielectric strength: Between input/output terminals and power terminal 2300V AC/minute; Between power terminal and protective conductor terminal 1500V AC/minute
- Protective structure: Only front panel has dust-proof and drip-proof structure equivalent to IP66.
- Material of case: PPO resin molding (equivalent to UL94V-1)
- External dimensions: SR91: H48 × W48 × D111 (Panel depth: 100) mm
SR92: H72 × W72 × D111 (Panel depth: 100) mm
SR93: H96 × W96 × D111 (Panel depth: 100) mm
SR94: H96 × W48 × D111 (Panel depth: 100) mm
- Mounting: Push-in panel (one-touch mount)
- Panel thickness: 1.0~4.0 mm
- Panel cutout: SR91: H45 × W45 mm
SR92: H68 × W68 mm
SR93: H92 × W92 mm
SR94: H92 × W45 mm
- Weight: SR91: Approximately 170 g
SR92: Approximately 280 g
SR93: Approximately 330 g
SR94: Approximately 240 g

—MEMO—

The contents of this manual are subject to change without notice.

Temperature and Humidity Control Specialists
SHIMADEN CO., LTD.

Head Office: 2-30-10 Kitamachi, Nerima-Ku, Tokyo 179-0081 Japan
Phone: +81-3-3931-7891 Fax: +81-3-3931-3089
E-MAIL: exp-dept@shimaden.co.jp URL: <http://www.shimaden.co.jp>

PRINTED IN JAPAN